

Your Global Automation Partner

TURCK

RU...High-End/3GD Ultrasonic Sensors with Ex Approvals

Instructions for Use



Contents

1	About These Instructions	5
1.1	Target groups.....	5
1.2	Explanation of symbols used	5
1.3	Other documents	5
1.4	Feedback about these instructions.....	5
2	Notes on the Product.....	6
2.1	Product identification.....	6
2.2	Scope of delivery	6
2.3	Legal requirements	6
2.4	Turck service.....	6
3	For Your Safety.....	7
3.1	Intended use.....	7
3.2	Obvious misuse.....	7
3.3	General safety instructions.....	7
3.4	Notes on Ex protection.....	7
3.4.1	Special conditions apply to use in Zone 2 (requirements of test authority)	7
4	Product Description	8
4.1	Device overview	8
4.1.1	Indication elements	8
4.2	Properties and features.....	9
4.3	Operating principle.....	9
4.4	Functions and operating modes	10
4.4.1	Setting options	10
4.4.2	Diffuse mode sensor	10
4.4.3	Retroreflective mode	13
4.4.4	IO-Link mode.....	13
4.5	Technical accessories.....	16
5	Installing.....	18
6	Connection.....	19
6.1	Connection diagram	19
6.2	Connection – multiplex mode	20
6.3	Connection – synchronization mode	21
6.4	Connection – enable mode	22
6.5	Connection – opposed mode.....	22
7	Commissioning	23
8	Operation	24
8.1	Operation as a diffuse mode sensor – LEDs	24
8.2	Operation as a retroreflective sensor – LEDs	24
8.3	Operation in IO-Link mode – LEDs	24

9	Setting	25
9.1	Setting via teach adapter.....	26
9.2	Setting by manual bridging (shorting)	35
9.3	Setting via the pushbuttons.....	44
9.4	Setting via IO-Link.....	52
10	Troubleshooting	53
11	Maintenance	54
12	Repair	54
12.1	Returning devices.....	54
13	Disposal	54
14	Technical Data	55
15	Appendix.....	56
15.1	Approvals and markings.....	56
15.2	Approvals: cULus.....	56
15.3	Conformity Certificates	57
15.4	Approvals.....	58
15.4.1	EC-type examination certificate	58
15.4.2	IECEX	61
16	Turck Subsidiaries - Contact Information	66

1 About These Instructions

These instructions for use describe the structure, functions and the use of the product and will help you to operate the product as intended. Read these instructions carefully before using the product. This is to avoid possible damage to persons, property or the device. Retain the instructions for future use during the service life of the product. If the product is passed on, pass on these instructions as well.

1.1 Target groups

These instructions are aimed at qualified personnel with knowledge of explosion protection (e.g. EN 60079-14 etc.) and must be carefully read by anyone mounting, commissioning, operating, maintaining, dismantling or disposing of the device.

1.2 Explanation of symbols used

The following symbols are used in these instructions:



DANGER

DANGER indicates a dangerous situation with high risk of death or severe injury if not avoided.



WARNING

WARNING indicates a dangerous situation with medium risk of death or severe injury if not avoided.



CAUTION

CAUTION indicates a dangerous situation of medium risk which may result in minor or moderate injury if not avoided.



NOTICE

NOTICE indicates a situation which may lead to property damage if not avoided.



NOTE

NOTE indicates tips, recommendations and useful information on specific actions and facts. The notes simplify your work and help you to avoid additional work.



CALL TO ACTION

This symbol denotes actions that the user must carry out.



RESULTS OF ACTION

This symbol denotes relevant results of actions.

1.3 Other documents

Besides this document the following material can be found on the Internet at www.turck.com:

- Data sheet
- Commissioning manual IO-Link devices
- IO-Link parameters manual
- EU Declaration of Conformity (current version)
- Approvals

1.4 Feedback about these instructions

We make every effort to ensure that these instructions are as informative and as clear as possible. If you have any suggestions for improving the design or if some information is missing in the document, please send your suggestions to techdoc@turck.com.

2 Notes on the Product

2.1 Product identification

RU 300 U - EM30 E - LIU2 PN 8 X2 T - H1 1 5 1 / 3GD

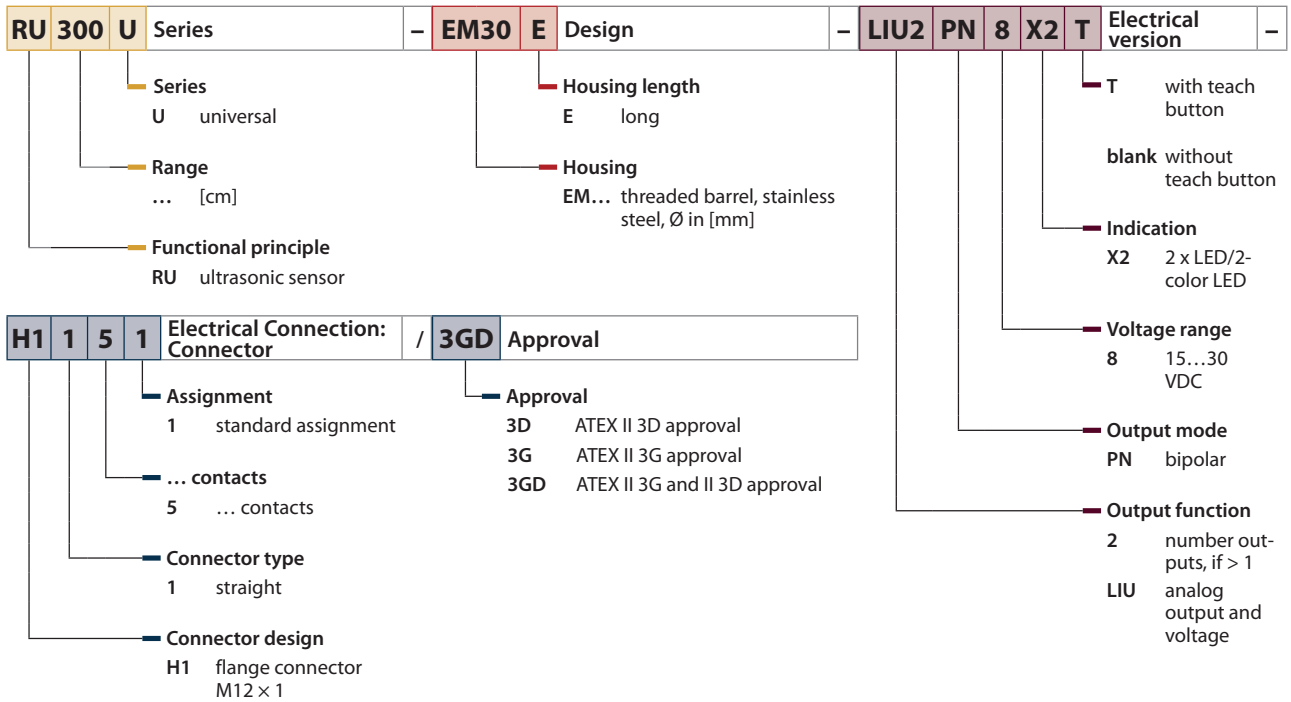

2.2 Scope of delivery

The scope of delivery includes:

- Ultrasonic sensor
- Two nuts for mounting
- Quick Start Guide
- SC-M12/3GD safety clip

2.3 Legal requirements

The device is subject to the following EC directives:

- 2014/30/EU (electromagnetic compatibility)
- 2014/34/EU (ATEX Directive)
- 2011/65/EU (RoHS Directive)

2.4 Turck service

Turck supports you with your projects, from initial analysis to the commissioning of your application. The Turck product database under www.turck.com contains software tools for programming, configuration or commissioning, data sheets and CAD files in numerous export formats.

The contact details of Turck subsidiaries worldwide can be found on p. [▶ 66].

3 For Your Safety

The product is designed according to state-of-the-art technology. However, residual risks still exist. Observe the following warnings and safety notices to prevent damage to persons and property. Turck accepts no liability for damage caused by failure to observe these warning and safety notices.

3.1 Intended use

These devices are designed solely for use in industrial areas.

The ultrasonic sensors of the High End series are intended for the contactless detection of solid or liquid objects as well as the distance to objects. The devices are suitable for use in Zone 2 and Zone 22.

The devices may only be used as described in these instructions. Any other use is not in accordance with the intended use. Turck accepts no liability for any resulting damage.

3.2 Obvious misuse

- The devices are not safety components and must not be used for personal or property protection.

3.3 General safety instructions

- The device may only be assembled, installed, operated, parameterized and maintained by professionally-trained personnel.
- The device may only be used in accordance with applicable national and international regulations, standards and laws.
- Not all objects are detected equally well by the sensor. The detection of the object must be checked by the user prior to regular operation.
- Strong air movements can disturb the correct function of the sensor and corrupt the measured values. Avoid air currents between the sensor and the object to be detected.

3.4 Notes on Ex protection

- When using the device in explosion-protection circuits, the user must have a working knowledge of explosion protection (EN 60079-14 etc.).
- Observe national and international regulations for explosion protection.
- Use the device only within the permissible operating and ambient conditions (see approval data and Ex approval specifications).

3.4.1 Special conditions apply to use in Zone 2 (requirements of test authority)

- Connect the device using a separately certified M12 plug connection. The plug connection must meet the requirements of IEC/EN 61076-2-101.
- Ensure external grounding through the installation.

4 Product Description

The devices are contained in a metal housing with an M18 or M30 male thread. The sonic transducer surface can be installed flush with the surrounding area.

All devices are provided with a metal M12 male connector for connecting the sensor cable. A switching distance can be set for object detection, which must be less than or equal to the maximum detection range, and greater than the minimum switching distance.

The ultrasonic sensors are provided with two switching outputs that can be set independently of each other. Output 1 can be used as a switching output, while output 2 can be used either as a switching output, current output or a voltage output. The sensors can be operated as diffuse mode or retroreflective sensors during normal operation.

The user can set an individual switch point as well as a window or hysteresis function. Other operation modes (opposed mode, multiplex, synchronous or enable mode) can be set via IO-Link.

4.1 Device overview

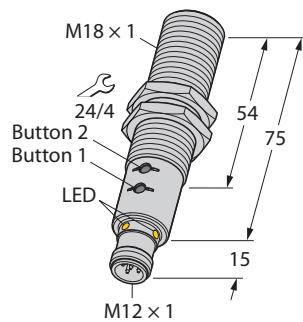

Fig. 1: Dimensions – RU...U-M18E-...

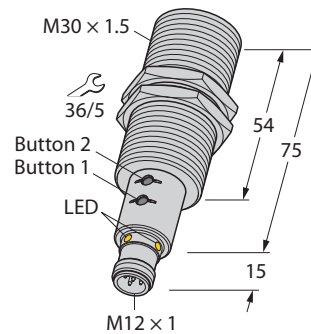

Fig. 2: Dimensions – RU...U-M30E-...

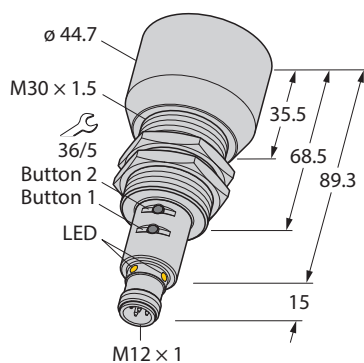

Fig. 3: Dimensions – RU600U-M30E-...

4.1.1 Indication elements

The ultrasonic sensors have a green and a yellow LED which are visible via four indication points. Only one LED can be active at one time. If an LED is active, all four indication points are lit.

4.2 Properties and features

- Smooth sonic transducer front
- Cylindrical design, potted
- M12 × 1 male connector
- Adjustable measuring range
- Temperature compensation
- NO/NC programmable
- Transmission of process value and parameterization via IO-Link

4.3 Operating principle

Ultrasonic sensors are designed for the non-contact and wear-free detection of a variety of targets by means of sound waves. It does not matter here whether the target is transparent or non-transparent, metallic or non-metallic, solid, liquid or in powder form. Environmental conditions such as spray, dust or rain also hardly affect the functioning of the sensors.

Ultrasonic sensors emit one or several ultrasonic pulses that are propagated in the air at the speed of sound. A part of the ultrasonic wave is reflected by the object. The sensor measures the total time of flight from the sensor to the object and back to the sensor. The distance to the object is then calculated with the following formula:

$$D = c \times t / 2$$

D Distance from the sensor to the object in m

c Speed of sound in air in m/s

t Time of flight for the ultrasonic pulse in s

To improve accuracy, the ultrasonic sensor forms the mean value from the measurement of several sound pulses before outputting a new value. The ultrasonic velocity depends on the composition and the temperature of the gas in which the sound is propagated. In most ultrasound applications, the composition of the gas is stable whereas the temperature may often fluctuate.

The speed of sound in air varies with the temperature according to the following approximation formula:

$$c_{\text{air}} = 20 \times \sqrt{(273 + T)}$$

c_{air} Speed of sound in air in m/s

T Temperature in °C

The speed of sound at an air temperature of 20 °C is approximately 344 m/s

The following formula applies to sensors with integrated temperature compensation:

$$c_{\text{air}} = (331.5 \times 0.596 + T)$$

Fluctuations in air temperature affect the speed of sound, which in turn has an effect on the total time for the echo measured by the sensor. An increase in air temperature shifts both measuring range limits closer to the sensor and the time of flight of the echo is shorter. A drop in air temperature shifts both measuring range limits away from the sensor and the time of flight of the echo is longer. This shift is approximately 3.5 % of the limit distance with a temperature change of 20 °C.

Good ultrasonic reflectors are metals, glass, stone, wood with smooth and hard surfaces, as well as liquids that are aligned appropriately to the sensor. Cloth, sand or grains absorb some of the sonic energy. Foams and skins are particularly poor reflectors.

4.4 Functions and operating modes

The ultrasonic sensors are provided with two outputs that can be set independently of each other. Output 1 can be used as a switching output, and output 2 can either be used as a switching output, current output (4...20 mA/0...20 mA) or voltage output (0...10 V/0...5 V/1...6 V). The start and end point of the measuring range can be set for the outputs. The measuring range must be within the detection range. The sensors can be run in normal operation as a diffuse mode or retroreflective sensor. The user can set an individual switching point as well as a window or hysteresis function.

Other operating modes (opposed, multiplex, synchronization or enable mode) can be parameterized via IO-Link.

4.4.1 Setting options

The devices feature the following setting options:

- Setting by manual bridging (shorting)
- Setting with connected teach adapter (accessories to be ordered separately)
- Setting via the pushbuttons
- Setting via IO-Link

4.4.2 Diffuse mode sensor

The diffuse mode is the standard operating mode of most ultrasonic sensors. The sensor detects the required object via the echo of the ultrasonic waves. The distance to an object is determined from the time of flight. Any additional wiring or accessories are not required.

When using diffuse mode sensors, a switching point or switch window is defined. The switch window is used for window or hysteresis functions.

Diffuse mode sensor with NC function

When used as a diffuse mode sensor with an NC function, a switching point is taught in for a switch output. The output behaves as follows:

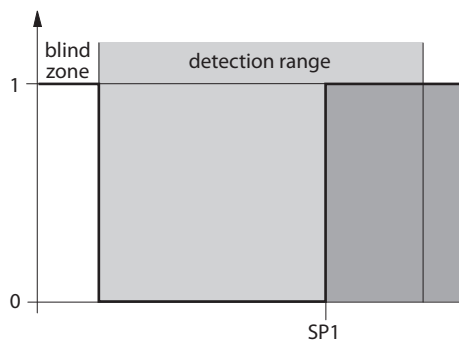

Fig. 4: Diffuse mode sensor with NC function – Behavior of the switching output

Diffuse mode sensor with NO function

When used a diffuse mode sensor with an NO function, a switching point is taught in for a switch output. The output behaves as follows:

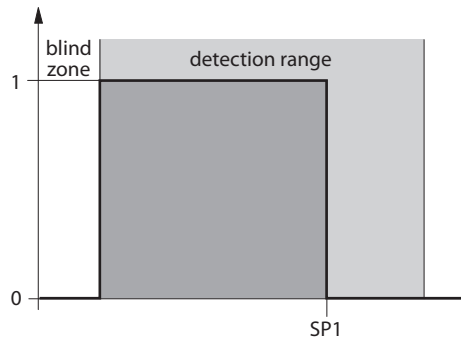

Fig. 5: Diffuse mode sensor with NO function – Behavior of the switching output

Window function

The start and end point of the switch window range can be set for the outputs. The switch window must be within the detection range.

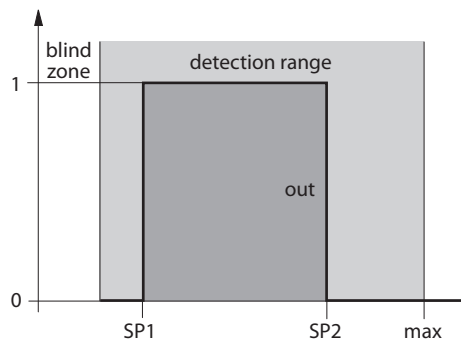

Fig. 6: Window function – Behavior of the switching output

Hysteresis function

When using the hysteresis function, a switch window is taught in that is defined by two switching points. The switching outputs have the following behavior as outputs:

If an object is moved away from the sensor, the switching output is switched on for as long as the object is located between the beginning of the detection range and switching point 2. If the object passes switching point 2, the switching output is switched off. If an object is moved towards the sensor, the switching output is switched off for as long as the object is located between the beginning of the detection range and switching point 1. If the object passes switching point 1, the switching output is switched on.

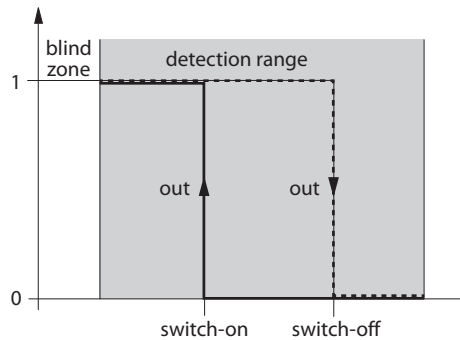

Fig. 7: Hysteresis function – behavior of switching output

Behavior of the analog output

Output 2 is factory set as an analog output and can be used either as a 4...20 mA/0...20 mA current output, a 0...10 V/0...5 V/1...6 V voltage output or as a switching output. The analog output behaves as follows:

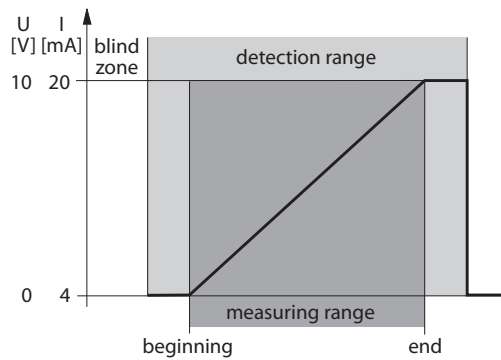

Fig. 8: Analog output – output behavior

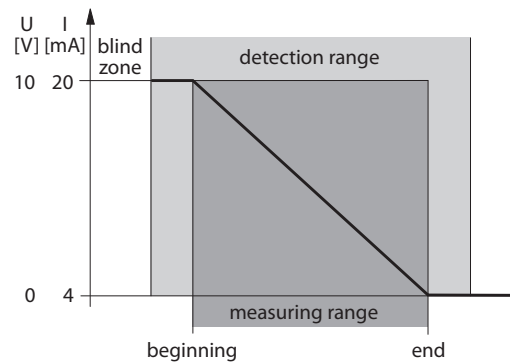

Fig. 9: Analog output inverted – output behavior

4.4.3 Retroreflective mode

When used as a retroreflective sensor, the sensor detects the echo of the ultrasonic waves of the taught reflector. The reflector can be any object with a surface that is as smooth as possible. The sensor generates a short switching window around the position of the reflector and detects the echo. The sensor switches if the echo is blocked or deflected by another object.

This operating mode is normally more reliable than the diffuse mode and is particularly suitable for objects that are difficult to detect and in difficult ambient conditions.

Any additional wiring or accessories are not required.

Synchronization with other sensors is not possible in this operating mode.

When used as a retroreflective sensor switching output 2 is switched on. The behavior of switching output 1 is inverted in relation to switching output 2.

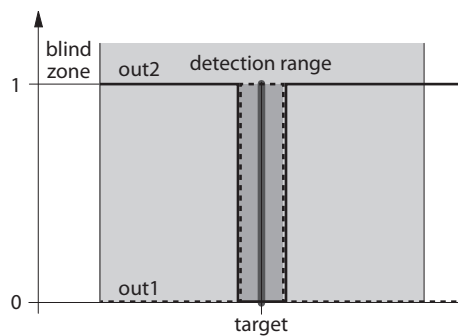

Fig. 10: Retroreflective mode – behavior of the switching output

4.4.4 IO-Link mode

Additional operating modes that cannot be implemented via the pushbuttons or the teach-in input can be set via IO-Link. These include the following operating modes:

- Multiplex mode
- Synchronization mode
- Enable mode
- Opposed mode

IO-Link is only required for setting up the device. The IODD of the device must be incorporated in an FDT frame (e.g. Pactware). The operating modes can be set via FDT/IODD.

The operating modes cannot be combined with each other. The appropriate bit is used in the process output data for synchronizing or multiplexing via the IO-Link process data. The sensors do not have to be wired together in this case. The time sequence is controlled by the IO-Link master.

Multiplex mode

Multiplex mode is used in order to prevent the mutual interaction of the sensors with the same ultrasonic frequency. Up to ten devices can be operated in succession. Each sensor operates at a fixed time, while all other sensors stay in wait mode. Multiplex mode can be set once for all sensors via IO-Link. Each sensor is assigned a unique address between 1 and 10. The device with the highest set number acts as the time base. This requires the sensors to be interconnected.



NOTE

Multiplex mode is only possible with devices of the same type

In multiplex mode, all connected sensors must have the same power rating and range. In multiplex mode only connect sensors with the same ID. The ID is printed on each device.

Output 1 on the master device is not available in this mode. A teach-in operation is not possible in this mode during operation. No other accessories are required for operation.

Synchronization mode

Synchronization mode allows sensors with the same ultrasonic frequency to operate without any mutual interaction. Mutual interaction is avoided as all sensors send and receive at the same time. Any number of ultrasonic sensors can be operated in synchronization mode. The devices do not need to be addressed. One of the sensors involved is defined as the time base via the wiring.



NOTE

Synchronization mode is only possible with devices of the same type

In synchronization mode, all connected sensors must have the same power rating and range. In synchronization mode, only connect sensors with the same ID. The ID is printed on each device.

Output 1 on the master device is not available in this mode. A teach-in operation is not possible in this mode during operation. No other accessories are required for operation.

Enable mode

Enable mode enables the targeted activation and deactivation of the sonic transducer of individual sensors. Each sensor is only active in release mode if a signal to U_b is present on pin 5. Enable mode enables the synchronization or multiplexing of sensors to be implemented. In enable mode, sensors with different power ratings and ranges can be used at the same time. An ultrasonic sensor is not used as the time base. The signal must be switched externally to each device via a PLC. The sensors do not have to be interconnected. Inactive sensors output the last valid value measured. The outputs can be used in the normal way. IO-Link operation is not possible in this mode.

Opposed mode

Two sensors with the same power rating and range are required for opposed mode. One sensor operates here exclusively as an emitter and one sensor exclusively as a receiver. The devices are positioned and aligned opposite each other. This makes it possible to double the effective range of the sensors. The opposed mode is the most reliable of all operating modes. All objects that interrupt the sound are detected. The wiring determines whether a device operates as an emitter or receiver.



NOTE

Opposed mode is only possible with devices of the same type

In opposed mode, all connected sensors must have the same power rating and range. In opposed mode, only connect sensors with the same ID. The ID is printed on each device.

The sensor connected as the emitter does not have any outputs available. The receiver only provides one switching output on pin 4. IO-Link operation is not possible.

4.5 Technical accessories

The following accessories are not supplied with the device:

Dimension drawing	Type	ID	Description
	TX1-Q20L60	6967114	Teach adapter
	USB-2-IOL-0002	6825482	IO-Link adapter V1.1 with integrated USB interface
	RKC4.5T-2-RSC4.5T/TEL	6625212	Connection cable, M12 female connector, straight, 5-pin, M12 male connector, straight, 5-pin, cable length: 2 m, sheathing material: PVC, black; cULus approval; other cable lengths and qualities available, see www.turck.com
	RKC4.5-2/TEL	6625016	Connection cable, M12 female connector, straight, 5-pin, cable length: 2 m, sheathing material: PVC, black; cULus approval; other cable lengths and qualities available, see www.turck.com

Dimension drawing

Type

ID

Description

WKC4.5T-2/
TEL

6625028

Connection cable, M12 female connector, angled, 5-pin, cable length: 2 m, sheathing material: PVC, black; cULus approval; other cable lengths and qualities available, see www.turck.com

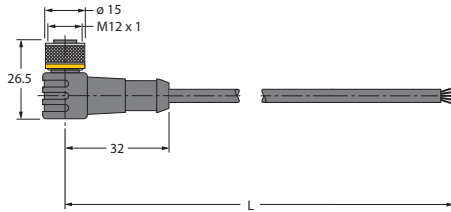

MW-18

6945004

Mounting bracket, stainless steel, for M18

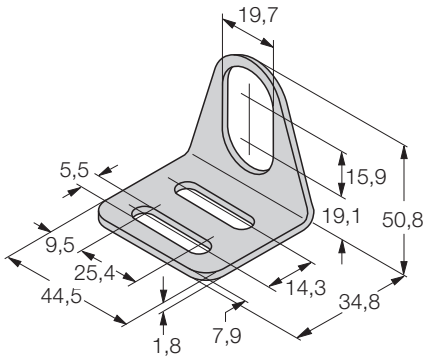

MW-30

6945005

Mounting bracket, stainless steel, for M30

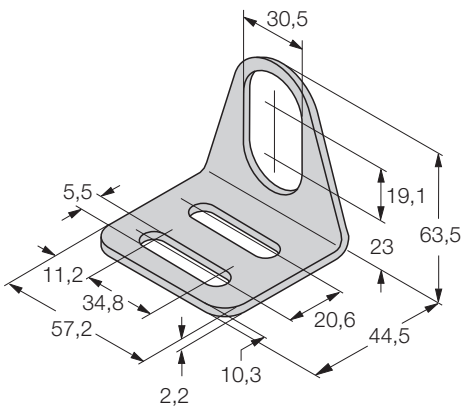

In addition to the above connection cables, Turck also offers other cable types for specific applications with the correct terminals for the device. More information on this is available from the Turck product database at www.turck.de/products in the Connectivity area.

5 Installing



DANGER

Potentially explosive atmosphere

Risk of explosion through spark ignition

Use of devices in Zone 2 and Zone 22:

- ▶ Only install the device if there is no potentially explosive atmosphere present.
- ▶ Protect the device's connector against accidental removal during operation using safety clip SC-M12/3GD (supplied with the device).



NOTE

When using more than one ultrasonic sensor in an application: Avoid the overlapping of sonic cones.

This can occur if two sensors are mounted less than 200 mm (RU40...), 450 mm (RU130...), 1000 mm (RU300...) or 2000 mm (RU600...) apart.

- ▶ If this distance is undershot, synchronize the sensors using IO-Link.

The sensors can be mounted in any direction. The maximum tightening torque for fastening the sensors is 20 Nm.

- ▶ Clean the mounting surface and its surroundings.
- ▶ When using a mounting aid: Fasten the sensor in the mounting aid.
- ▶ Install the sensor or mounting aid at the intended position.
- ▶ Ensure that the rear plug connector is accessible.
- ▶ Mount the sensor so that the blind zone is clear of any relevant objects (see wave patterns or technical data).

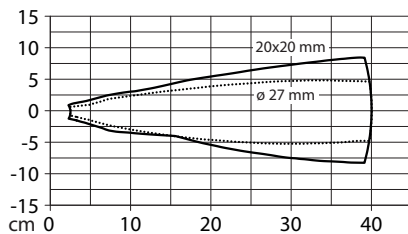

Fig. 11: RU40... wave pattern

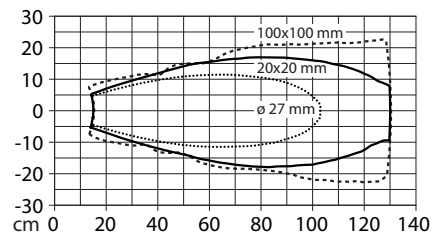

Fig. 12: RU130... wave pattern

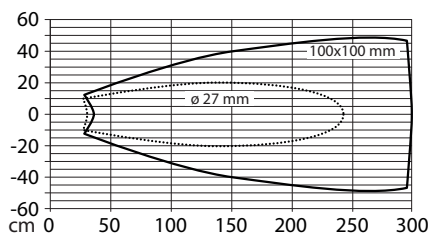

Fig. 13: RU300... wave pattern

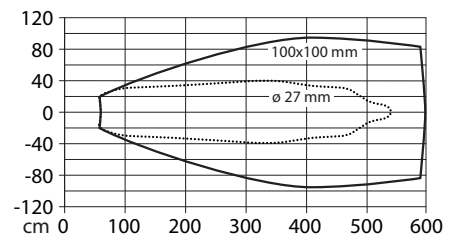

Fig. 14: RU600... wave pattern

6 Connection



DANGER

Potentially explosive atmosphere

Risk of explosion through spark ignition

Use of devices in Zone 2 and Zone 22:

- ▶ Only connect the device for use in Zone 2 if there is no potentially explosive atmosphere present.
- ▶ Protect the device's connector against accidental removal during operation using safety clip SC-M12/3GD (supplied with the device).

- ▶ Connect the female connector of the connection cable to the male connector of the sensor.
- ▶ Connect the open end of the connection cable to the power supply and/or processing units.

6.1 Connection diagram

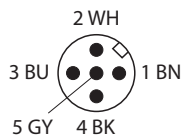

Fig. 15: Pin assignment

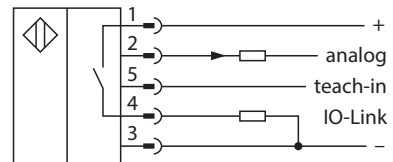

Fig. 16: Connection diagram

6.2 Connection – multiplex mode

- ▶ Sensors must be connected to the master sensor according to the following wiring diagram.

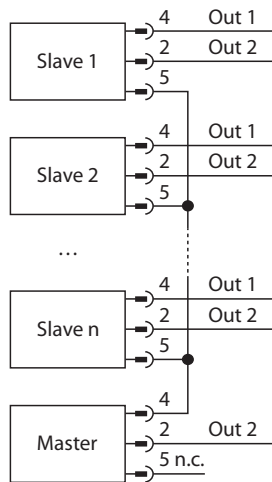

Fig. 17: Wiring diagram – multiplex mode

Connection diagram of the master sensor in multiplex mode

Pin	Pin assignment
Pin 1	+24 VDC
Pin 2	Output 2 (analog output or switching output)
Pin 3	GND
Pin 4	Multiplex output, connected to pin 5 of the slaves
Pin 5	Not connected (n. c.)

A circular 5-pin connector diagram for the master sensor. The pins are labeled: 2 WH (top), 3 BU (left), 1 BN (right), 5 GY (bottom-left), and 4 BK (bottom-right).

Connection diagram of the slaves in multiplex mode

Pin	Pin assignment
Pin 1	+24 VDC
Pin 2	Output 2 (analog output or switching output)
Pin 3	GND
Pin 4	Output 1 (switching output)
Pin 5	Multiplex input, connected to pin 4 of the master sensor

A circular 5-pin connector diagram for the slave sensor. The pins are labeled: 2 WH (top), 3 BU (left), 1 BN (right), 5 GY (bottom-left), and 4 BK (bottom-right).

6.3 Connection – synchronization mode

- Sensors must be connected to the master sensor according to the following wiring diagram:

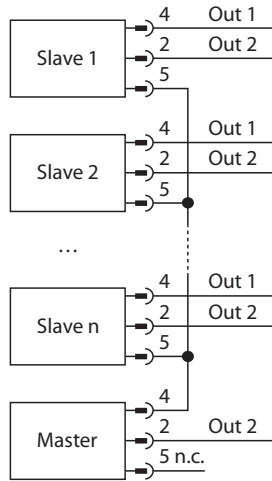

Fig. 18: Wiring diagram – synchronization mode

The sensors do not have to be addressed. The master sensor controls all sensors in a fixed time cycle with a trigger signal via pin 4:

RU40U...	RU130U...	RU300U...	RU600U...
22 ms	17.4 ms	37.4 ms	75.4 ms

Connection diagram of the master sensor in synchronization mode

Pin	Pin assignment
Pin 1	+24 VDC
Pin 2	Output 2 (analog output or switching output)
Pin 3	GND
Pin 4	Synchronization output, connected to pin 5 of the slaves
Pin 5	Not connected (n. c.)

Connection diagram of the slaves in synchronization mode

Pin	Pin assignment
Pin 1	+24 VDC
Pin 2	Output 2 (analog output or switching output)
Pin 3	GND
Pin 4	Output 1 (switching output)
Pin 5	Synchronization input, connected to pin 4 of the master sensor

6.4 Connection – enable mode

Connection diagram of the sensors in enable mode

Pin	Pin assignment
Pin 1	+24 VDC
Pin 2	Output 2 (analog output or switching output)
Pin 3	GND
Pin 4	Output 1 (switching output)
Pin 5	Release input Enable: +24 VDC Disable: GND or open

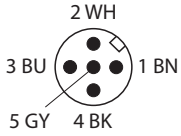

The diagram shows a 5-pin connector with the following color coding: 1 BN (brown), 2 WH (white), 3 BU (blue), 4 BK (black), and 5 GY (grey). A diagonal line is drawn through the connector, separating pins 1-3 from pins 4-5.

6.5 Connection – opposed mode

Pin assignment of the emitters in opposed mode

Pin	Pin assignment
Pin 1	+24 VDC
Pin 2	No function
Pin 3	GND
Pin 4	Trigger output, connected to pin 5 of the receiver
Pin 5	Not connected (n. c.)

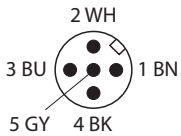

The diagram shows a 5-pin connector with the following color coding: 1 BN (brown), 2 WH (white), 3 BU (blue), 4 BK (black), and 5 GY (grey). A diagonal line is drawn through the connector, separating pins 1-3 from pins 4-5.

Pin assignment of the receiver in opposed mode

Pin	Pin assignment
Pin 1	+24 VDC
Pin 2	No function
Pin 3	GND
Pin 4	Output signal for object detection, signal according to the table below
Pin 5	Trigger input, connected to pin 4 of the emitter

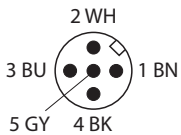

The diagram shows a 5-pin connector with the following color coding: 1 BN (brown), 2 WH (white), 3 BU (blue), 4 BK (black), and 5 GY (grey). A diagonal line is drawn through the connector, separating pins 1-3 from pins 4-5.

7 Commissioning

The device is operational automatically once the cables are connected and the power supply is switched on.

8 Operation



NOTICE

Incorrect use of the sensor

Possible damage to property due to malfunction

- ▶ Prevent the accumulation of material deposits on the surface of the sonic transducer.
- ▶ Keep the blind zone of the sensor clear. Refer to the technical data for the blind zone S_{min} of the sensor.

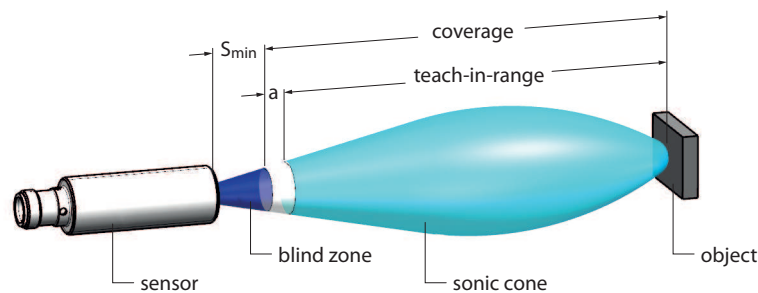

Fig. 19: Sonic cone and spread of the blind zone (schematic)

8.1 Operation as a diffuse mode sensor – LEDs

In diffuse mode the LEDs have the following indication functions:

LED indication	Meaning
Yellow	NO contact: Object within the teach-in range, switching output 1 on NC contact: No object in teach range, switching output 1 on
Green	NO contact: Object within the detection range, switching output 1 off NC contact: Object within the teach-in range, switching output 1 off
Off (only NO contact)	No object within the detection range, switching output 1 off

8.2 Operation as a retroreflective sensor – LEDs

In retroreflective mode the LEDs have the following indication functions:

LED	Meaning
Yellow	Reflector present, switching output 1 on
Green	Object between sensor and reflector, switching output 1 off
Off	No object within the detection range, switching output 1 off

Switching output 2 inverts the signal of switching output 1.

8.3 Operation in IO-Link mode – LEDs

In IO-Link mode the LEDs have the following indication function:

LED indication	Meaning
Green, lit with short interruptions	IO-Link mode started

9 Setting



DANGER

Potentially explosive atmosphere

Risk of explosion through spark ignition

- ▶ Only teach in the device if there is no potentially explosive atmosphere present.

The ultrasonic sensor has two outputs with individually adjustable limits. Output 2 is factory set as an analog output and can be used either as a current output, a voltage output or as a switching output. The user can set an individual switch point as well as a double switch point for the switching outputs. The double switch point is used for window or hysteresis functions. The output behavior of the switching outputs and the analog outputs is shown in the section Function and operating modes. The sensor switches automatically to normal operation after the teach-in operation is successfully completed.

Teach-in the devices as follows:

	Teach-in to GND	Teach-in to U _B
Teach adapter	Press the pushbutton to GND	Press the pushbutton to U _B
Manual bridging (shorting)	Bridge pin 3 (BU) with pin 5 (GY)	Bridge pin 1 (BN) with pin 5 (GY)
Pushbutton on the device	Press pushbutton 1	Press pushbutton 2

The TX1-Q20L60 teach adapter is not included in the scope of delivery. To use the teach adapter connect it between the sensor and the connection cable.

Aborting the teach-in operation: Teach-in U_B for at least 2 s.

Additional operating modes (e.g. multiplex, synchronization, release and opposed mode) and parameters can be set via IO-Link.

The flow charts illustrate the operating steps and the LED indication during the teach-in process.

9.1 Setting via teach adapter

Selecting the output

- ▶ Select switching output 1: Press and hold down the pushbutton on the adapter to GND for 2...7 s.
- ▶ Select output 2: Press and hold down the pushbutton on the adapter to GND for 8...13 s.

Setting the switching point

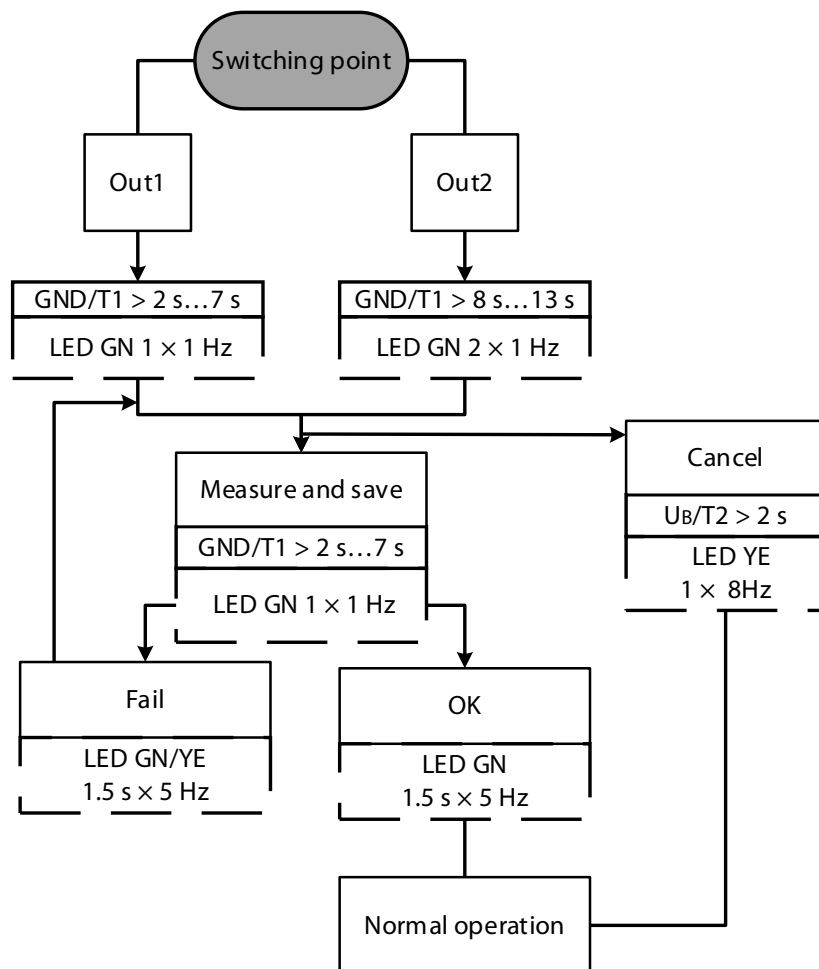

Fig. 20: Setting the switching point

- ▶ Connect the TX1-Q20L60 teach adapter between the sensor and the connection cable.
- ▶ Select the switching output.
- ▶ Position the object for the switching point.
- ▶ Store the switching point: Press and hold down the pushbutton on the adapter to GND for 2...7 s.
- ⇒ The individual switching point has been taught in successfully if the green LED flashes for 1.5 s at a frequency of 5 Hz.

Window function – setting the switching range

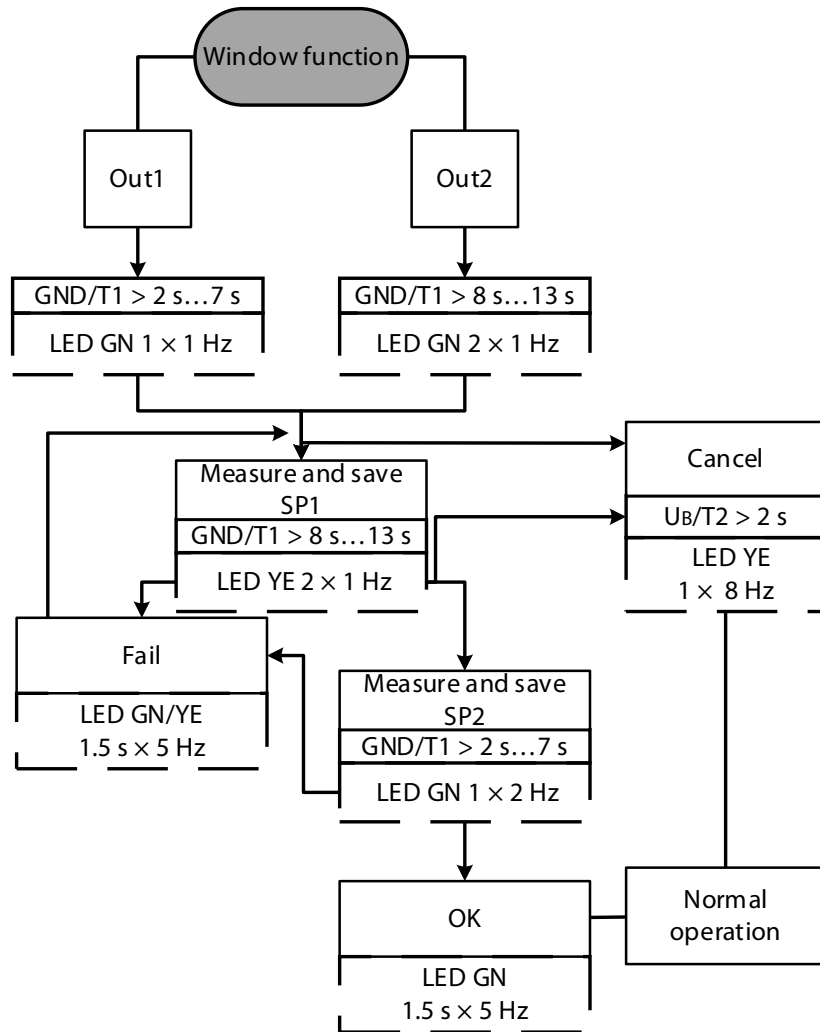

Fig. 21: Window function – setting the switching range

- ▶ Connect the TX1-Q20L60 teach adapter between the sensor and the connection cable.
- ▶ Position the object for switching point 1.
- ▶ Select the switching output.
- ▶ Store switching point 1: Press and hold down the pushbutton on the adapter to GND for 8...13 s.
- ▶ Position the object for switching point 2.
- ▶ Store switching point 2: Press and hold down the pushbutton on the adapter to GND for 2...7 s.
- ⇒ The switching points have been successfully taught in if the green LED flashes for 1.5 s at a frequency of 5 Hz.

Window function – switching between hysteresis and window

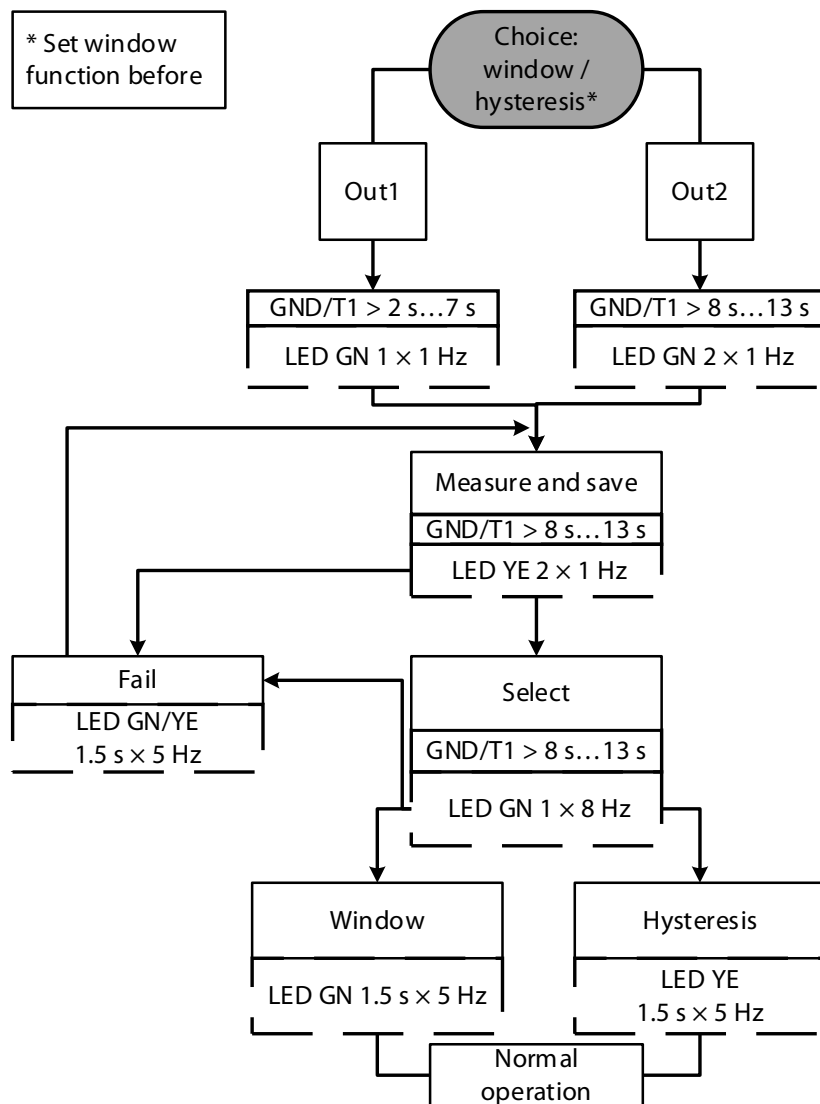

Fig. 22: Window function – switching between hysteresis and window

- ▶ Connect the TX1-Q20L60 teach adapter between the sensor and the connection cable.
- ▶ Select the switching output.
- ▶ Press and hold down the pushbutton on the adapter to GND for 14...19 s.
- ⇒ The output function has been successfully inverted as an NO contact if the green LED flashes for 1.5 s at a frequency of 5 Hz.
- ⇒ The output function has been successfully inverted as an NC contact if the yellow LED flashes for 1.5 s at a frequency of 5 Hz.

Inverting the output function (NO/NC)

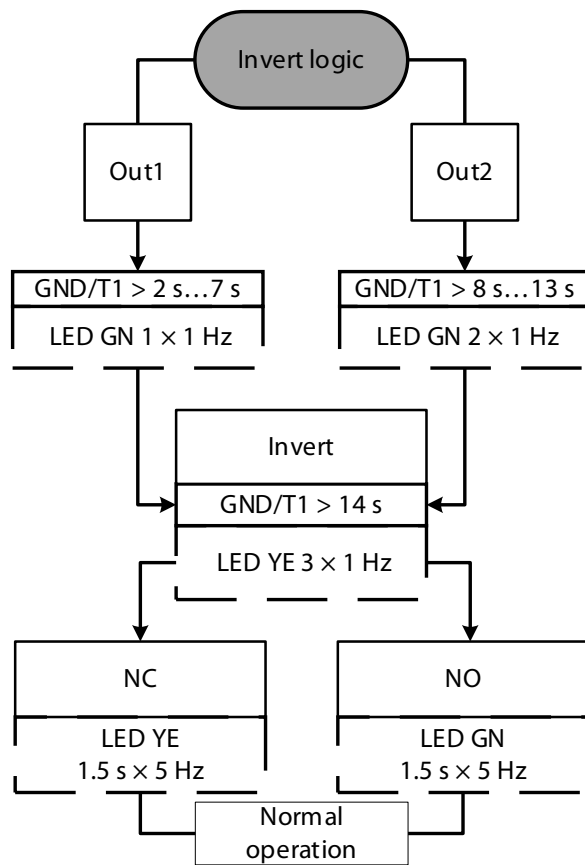

Fig. 23: Inverting the output function (NO/NC)

- ▶ Connect the TX1-Q20L60 teach adapter between the sensor and the connection cable.
- ▶ Select the switching output.
- ▶ Press and hold down the pushbutton on the adapter to GND for 14...19 s.
- ⇒ The output function has been successfully inverted as an NO contact if the green LED flashes for 1.5 s at a frequency of 5 Hz. The output function has been successfully inverted as an NC contact if the yellow LED flashes for 1.5 s at a frequency of 5 Hz.

Setting operation as a retroreflective sensor

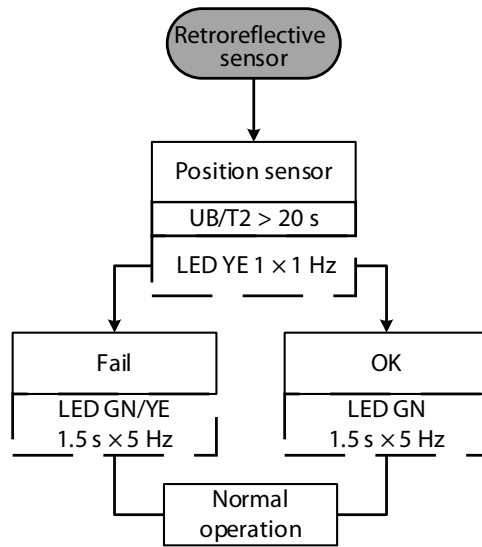

Fig. 24: Setting operation as a retroreflective sensor

- ▶ Connect the TX1-Q20L60 teach adapter between the sensor and the connection cable.
- ▶ Position the reflector in the detection range.
- ▶ Press and hold down the pushbutton on the adapter to U_b for at least 21 s.
- ⇒ The sensor is set successfully as a retroreflective sensor if the green LED flashes for 1.5 s at a frequency of 5 Hz.

Reset to factory settings

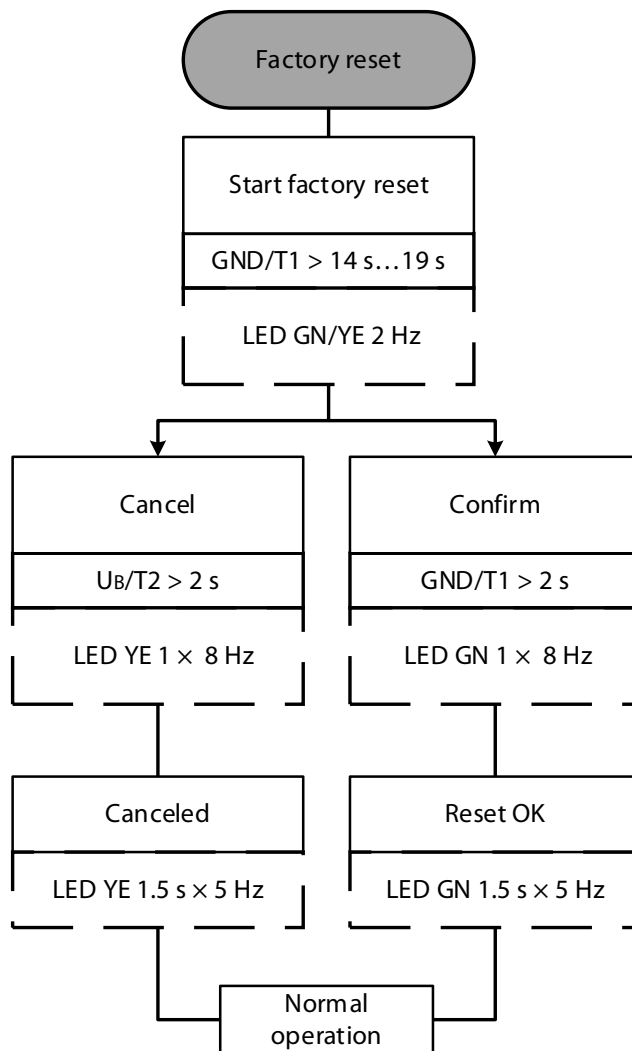

Fig. 25: Reset to factory settings

- ▶ Connect the TX1-Q20L60 teach adapter between the sensor and the connection cable.
- ▶ Starting the reset to factory settings: Press and hold down the pushbutton on the adapter to GND for 14...19 s.
- ▶ Confirming the reset to factory settings: Press and hold down the pushbutton on the adapter to GND for 2...7 s.
- ⇒ The device has been successfully reset to the factory settings if the green LED flashes for 1.5 s at a frequency of 5 Hz.

Setting output 2 as a current output



NOTE

If output 2 is set as a current output, the closer teach-in point corresponds to limit value 1 (4 mA) and the teach-in point further away to limit value 2 (20 mA).

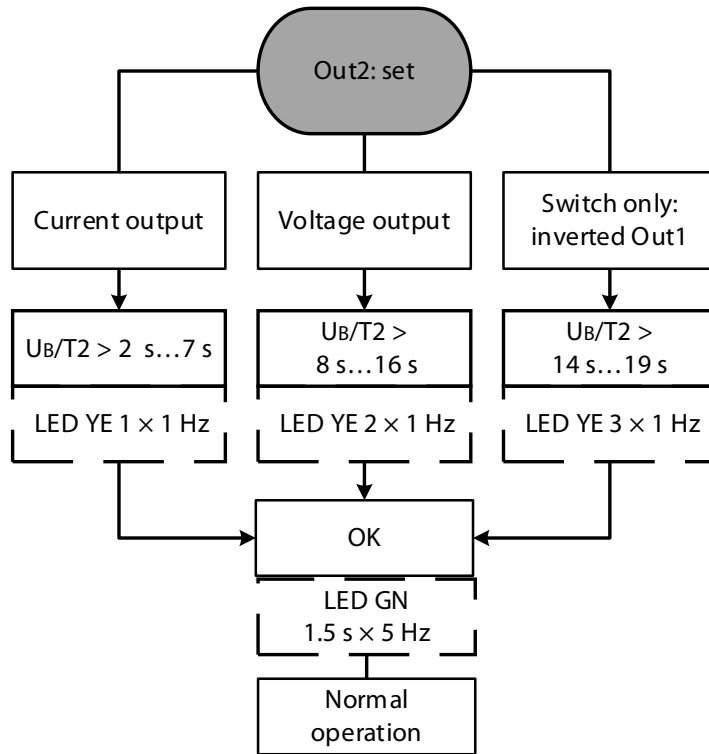

Fig. 26: Setting output 2

- ▶ Connect the TX1-Q20L60 teach adapter between the sensor and the connection cable.
- ▶ Press and hold down the pushbutton on the adapter to U_B for 2...7 s.
- ▶ Set limit values for the window function.
- ⇒ Output 2 is set successfully as a current output if the green LED flashes for 1.5 s at a frequency of 5 Hz.

Setting output 2 as a voltage output



NOTE

If output 2 is set as a voltage output, the closer teach-in point corresponds to limit value 1 (0 V) and the teach-in point further away to limit value 2 (10 V).

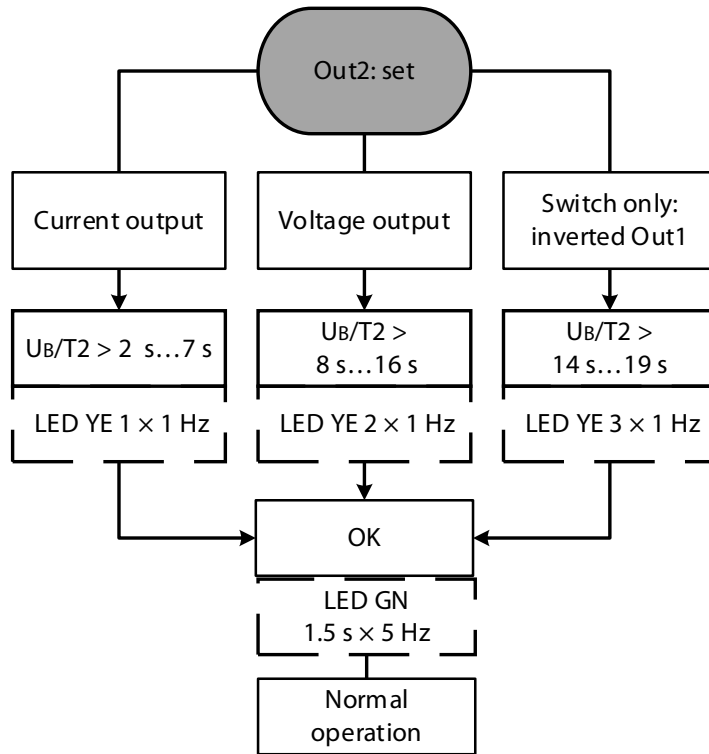

Fig. 27: Setting output 2

- ▶ Connect the TX1-Q20L60 teach adapter between the sensor and the connection cable.
- ▶ Press and hold down the pushbutton on the adapter for 8...13 s to U_B.
- ▶ Set limit values for the window function.
- ⇒ Output 2 is set successfully as a voltage output if the green LED flashes for 1.5 s at a frequency of 5 Hz.

Setting output 2 as a switching output

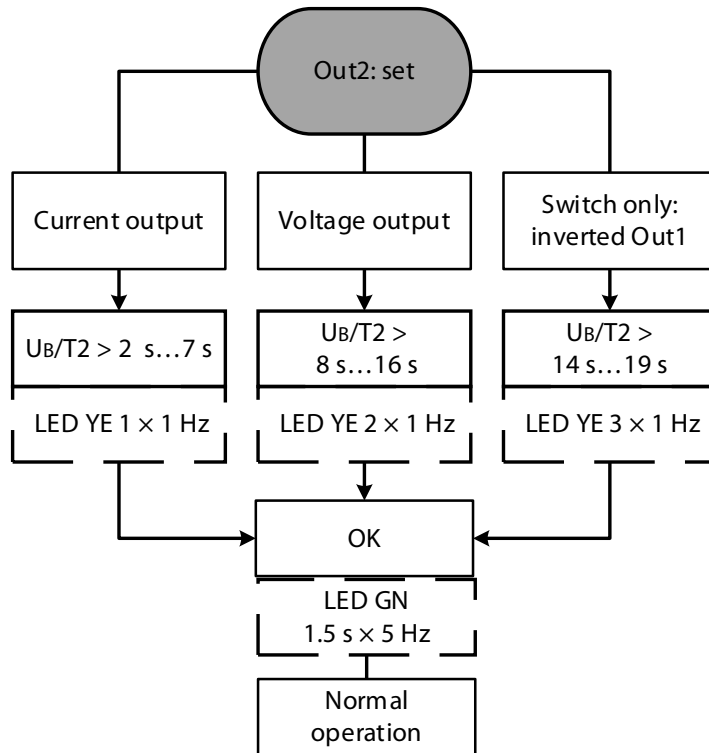

Fig. 28: Setting output 2

- ▶ Press and hold down the pushbutton on the adapter to U_B for 14...19 s.
- ⇒ Output 2 is set successfully as a switching output if the green LED flashes for 1.5 s at a frequency of 5 Hz.

9.2 Setting by manual bridging (shorting)

Selecting the output

- ▶ Select switching output 1: Bridge pin 3 (BU) with pin 5 (GY) for 2...7 s.
- ▶ Select output 2: Bridge pin 3 (BU) with pin 5 (GY) for 8...13 s.

Setting the switching point

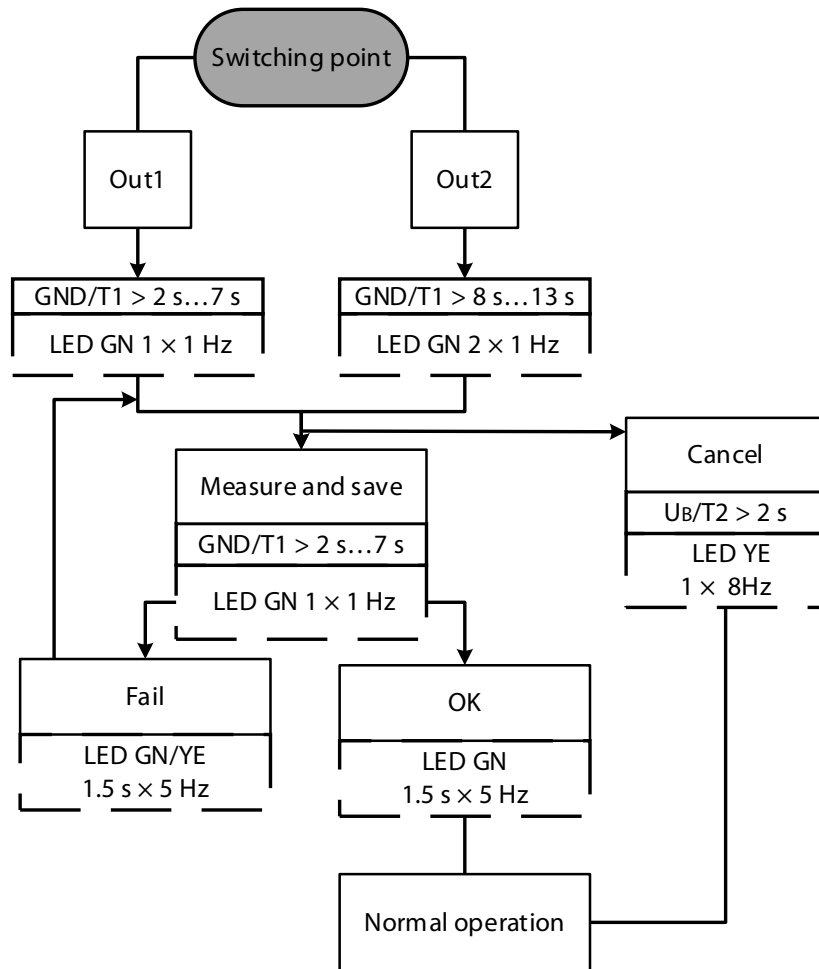

Fig. 29: Setting the switching point

- ▶ Select the switching output.
- ▶ Position the object for the switching point.
- ▶ Store the switching point: Bridge pin 3 (BU) with pin 5 (GY) for 2...7 s.
- ⇒ The individual switching point has been taught in successfully if the green LED flashes for 1.5 s at a frequency of 5 Hz.

Window function – setting the switching range

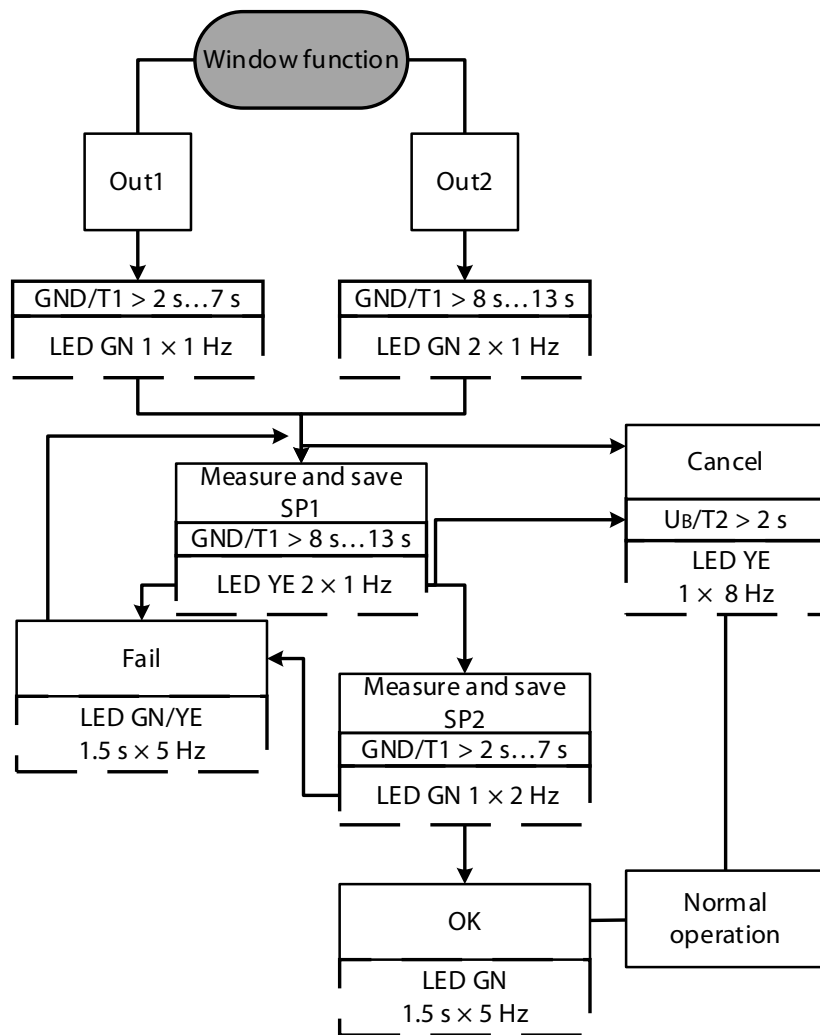

Fig. 30: Window function – setting the switching range

- ▶ Position the object for switching point 1.
- ▶ Store switching point 1: Bridge pin 3 (BU) with pin 5 (GY) for 8...13 s.
- ▶ Position the object for switching point 2.
- ▶ Store switching point 2: Bridge pin 3 (BU) with pin 5 (GY) for 2...7 s.
- ⇒ The switching points have been successfully taught in if the green LED flashes for 1.5 s at a frequency of 5 Hz.

Window function – switching between hysteresis and window

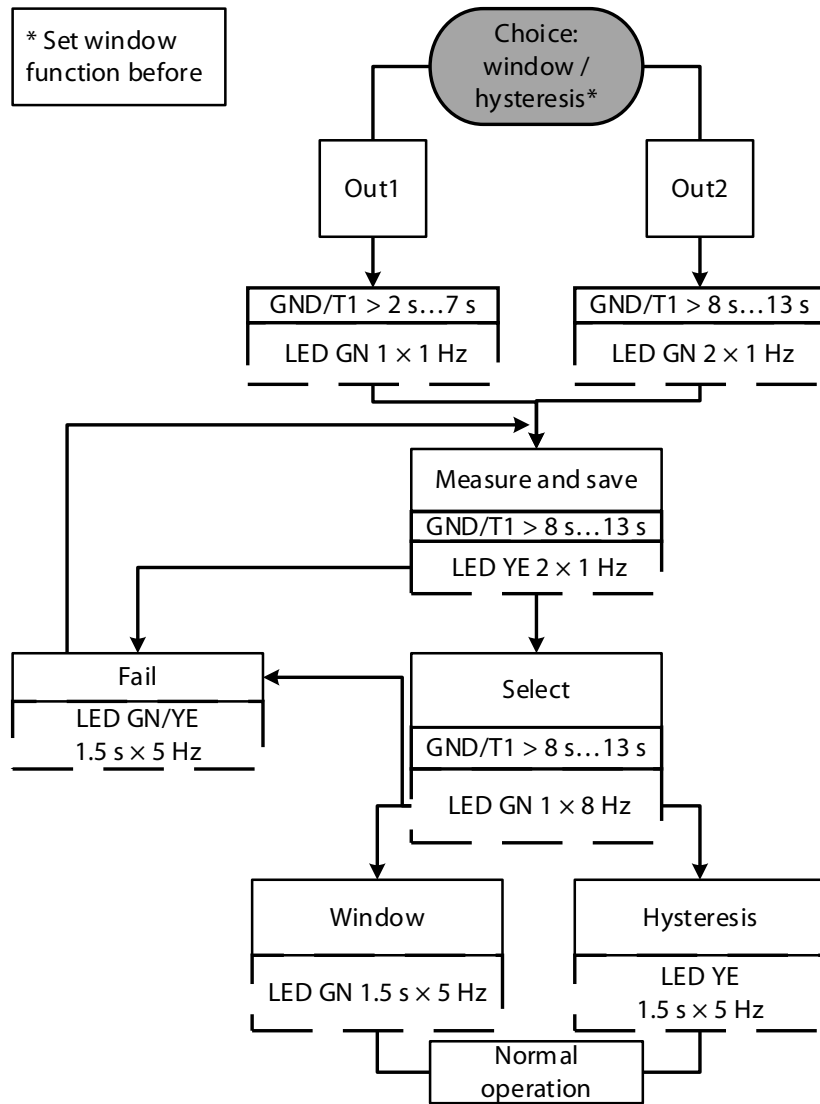

Fig. 31: Window function – switching between hysteresis and window

- ▶ Position the object at any point in the detection range.
- ▶ Bridge pin 3 (BU) with pin 5 (GY) for 14...19 s.
- ⇒ The output function has been successfully inverted as an NO contact if the green LED flashes for 1.5 s at a frequency of 5 Hz.
- ⇒ The output function has been successfully inverted as an NC contact if the yellow LED flashes for 1.5 s at a frequency of 5 Hz.

Inverting the output function (NO/NC)

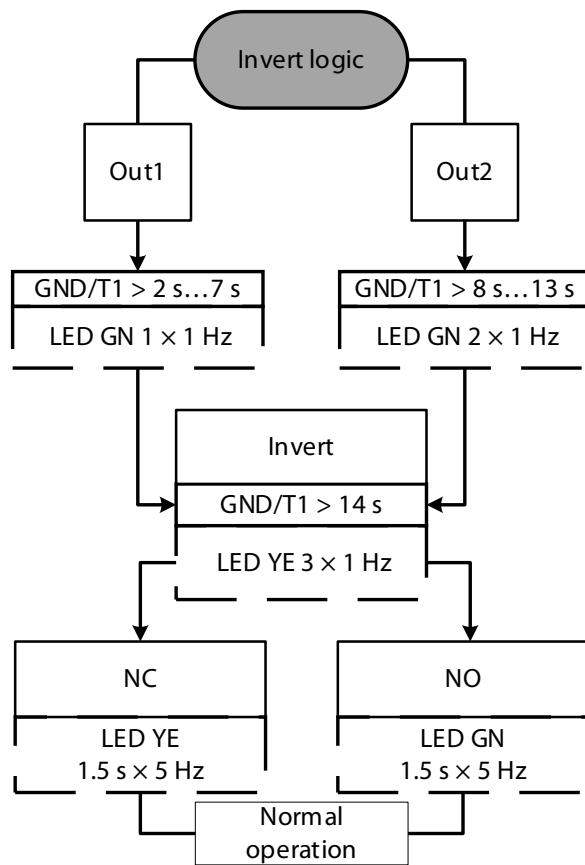

Fig. 32: Inverting the output function (NO/NC)

- ▶ Select the switching output.
- ▶ Bridge pin 3 (BU) with pin 5 (GY) for 14...19 s.
- ⇒ The output function has been successfully inverted as an NO contact if the green LED flashes for 1.5 s at a frequency of 5 Hz. The output function has been successfully inverted as an NC contact if the yellow LED flashes for 1.5 s at a frequency of 5 Hz.

Setting operation as a retroreflective sensor

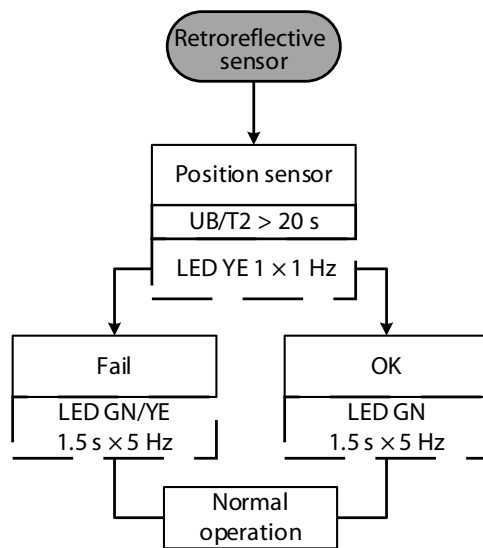

Fig. 33: Setting operation as a retroreflective sensor

- ▶ Position the reflector in the detection range.
- ▶ Bridge pin 1 (BN) with pin 5 (GY) for at least 21 s.
- ⇒ The sensor is set successfully as a retroreflective sensor if the green LED flashes for 1.5 s at a frequency of 5 Hz.

Reset to factory settings

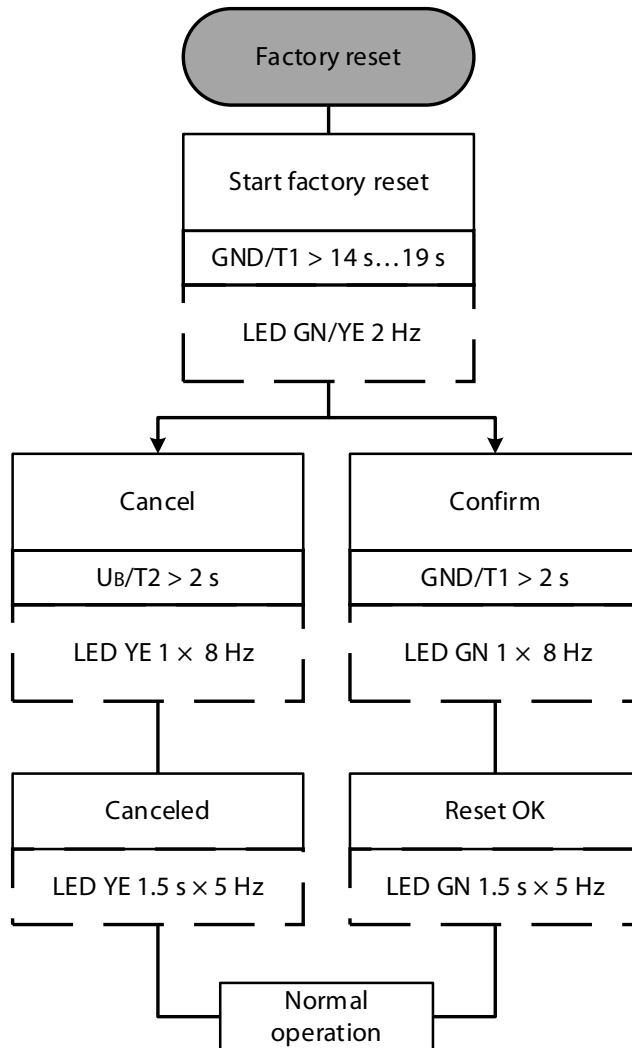

Fig. 34: Reset to factory settings

- ▶ Starting the reset to factory settings: Bridge pin 3 (BU) with pin 5 (GY) for 14...19 s.
- ▶ Confirming the reset to factory settings: Bridge pin 3 (BU) with pin 5 (GY) for 2...7 s.
- ⇒ The device has been successfully reset to the factory settings if the green LED flashes for 1.5 s at a frequency of 5 Hz.

Setting output 2 as a current output



NOTE

If output 2 is set as a current output, the closer teach-in point corresponds to limit value 1 (4 mA) and the teach-in point further away to limit value 2 (20 mA).

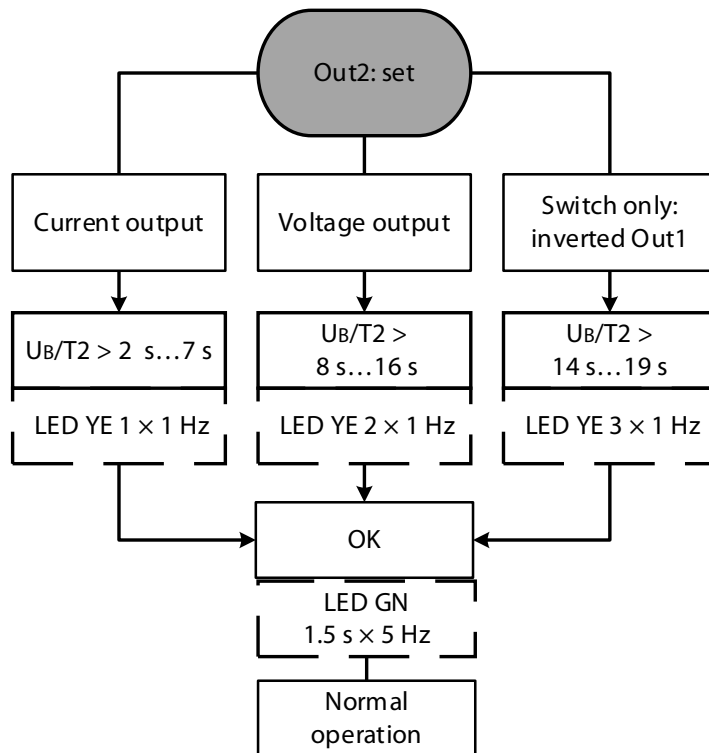

Fig. 35: Setting output 2

- ▶ Bridge pin 1 (BN) with pin 5 (GY) for 2...7 s.
- ▶ Set limit values for the window function.
- ⇒ Output 2 is set successfully as a current output if the green LED flashes for 1.5 s at a frequency of 5 Hz.

Setting output 2 as a voltage output



NOTE

If output 2 is set as a voltage output, the closer teach-in point corresponds to limit value 1 (0 V) and the teach-in point further away to limit value 2 (10 V).

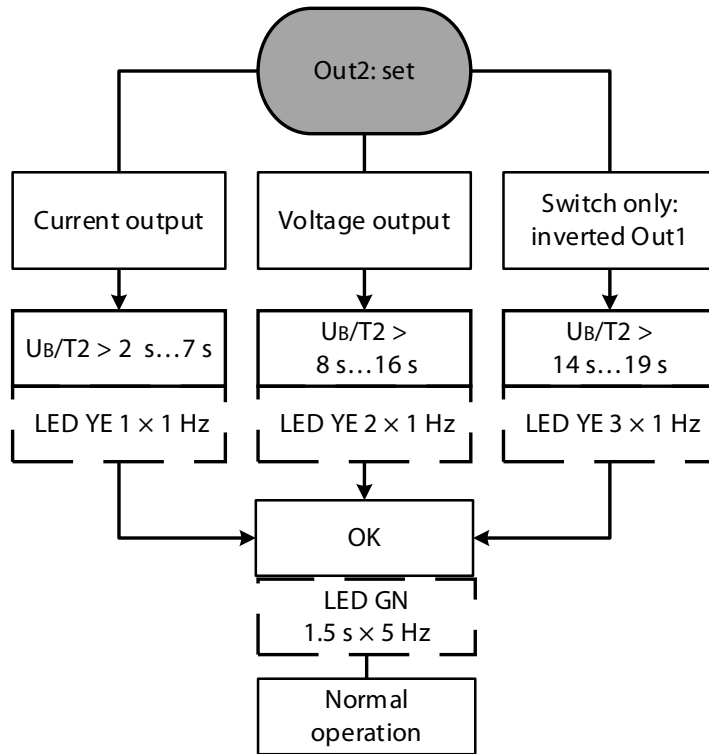

Fig. 36: Setting output 2

- ▶ Bridge pin 1 (BN) with pin 5 (GY) for 8...13 s.
- ▶ Set limit values for the window function.
- ⇒ Output 2 is set successfully as a voltage output if the green LED flashes for 1.5 s at a frequency of 5 Hz.

Setting output 2 as a switching output

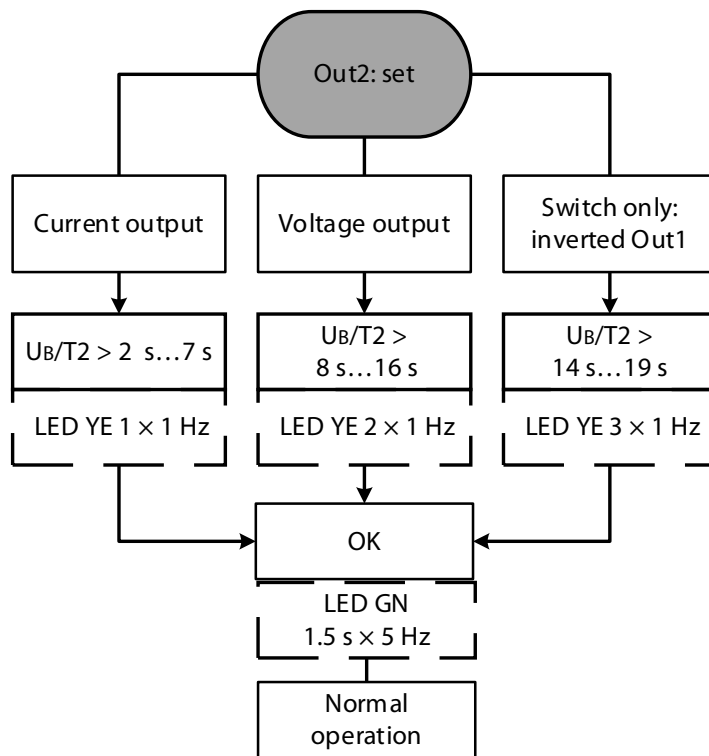

Fig. 37: Setting output 2

- ▶ Bridge pin 1 (BN) with pin 5 (GY) for 14...19 s.
- ⇒ Output 2 is set successfully as a switching output if the green LED flashes for 1.5 s at a frequency of 5 Hz.

9.3 Setting via the pushbuttons



NOTE

The devices with a teach button are ready for teaching in up to 300 s after the power supply is switched on. The teach button is then automatically locked. A new teach-in operation is only possible after the power supply has been reset.

Selecting the output

- ▶ Select switching output 1: Press and hold down pushbutton 1 for 2...7 s.
- ▶ Select output 2: Press and hold down pushbutton 1 for 8...13 s.

Setting the switching point

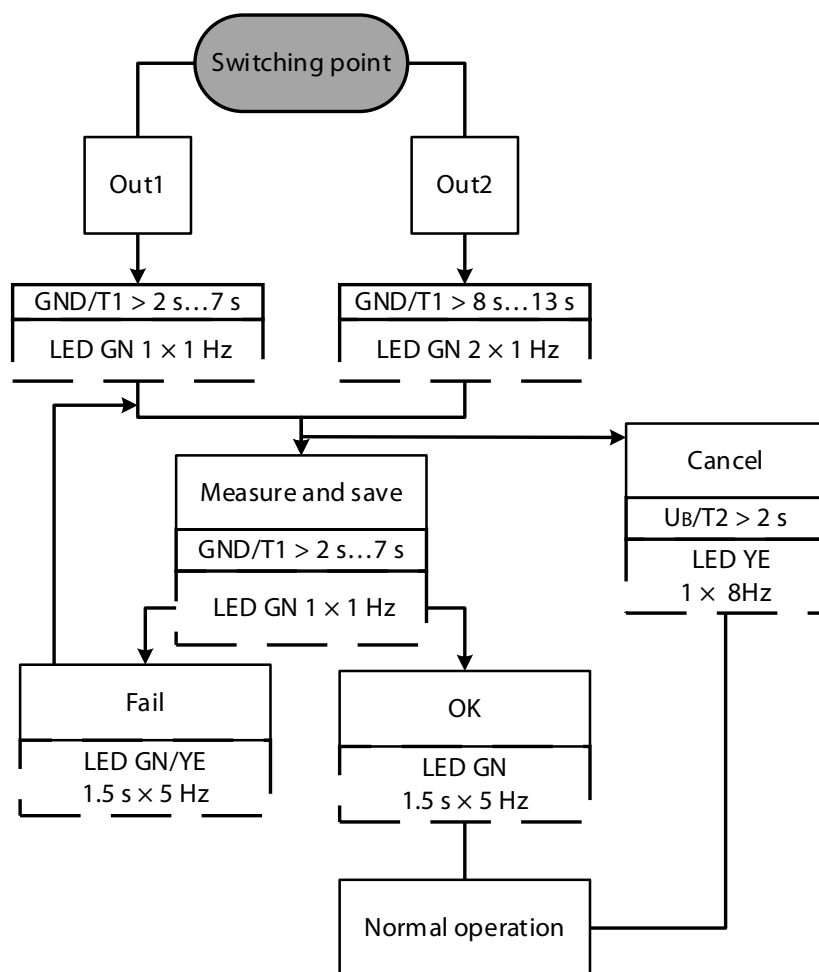

Fig. 38: Setting the switching point

- ▶ Select the switching output.
- ▶ Position the object for the switching point.
- ▶ Save the switching point: Press and hold down pushbutton 1 for 2...7 s.
- ⇒ The individual switching point has been taught successfully if the green LED flashes for 1.5 s at a frequency of 5 Hz.

Window function – setting the switching range

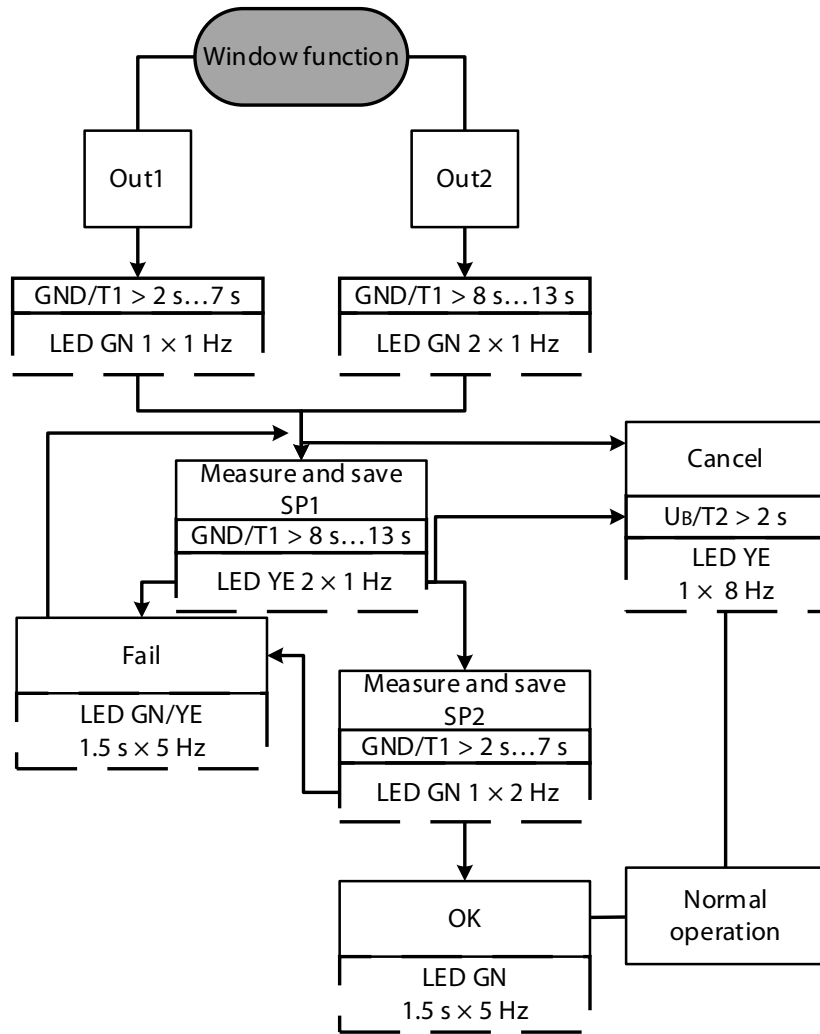

Fig. 39: Window function – setting the switching range

- ▶ Position the object for switching point 1.
- ▶ Select the switching output.
- ▶ Store switching point 1: Press and hold down pushbutton 1 for 8...13 s.
- ▶ Position the object for switching point 2.
- ▶ Store switching point 2: Press and hold down pushbutton 1 for 2...7 s.
- ⇒ The switching points have been successfully taught if the green LED flashes for 1.5 s at a frequency of 5 Hz.

Window function – switching between hysteresis and window

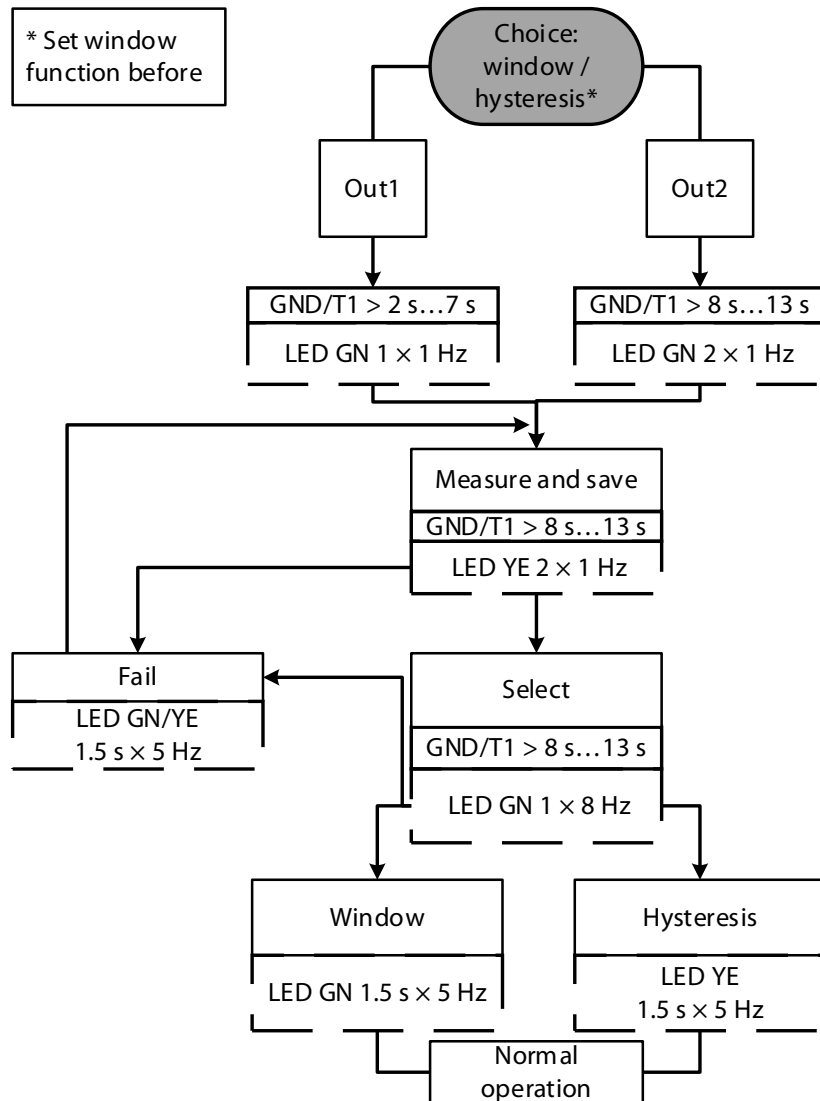

Fig. 40: Window function – switching between hysteresis and window

- ▶ Position the object at any point in the detection range.
- ▶ Press and hold down pushbutton 1 for 8...13 s.
- ▶ Press and hold down pushbutton 1 once more for 8...13 s.
- ⇒ The individual switching point has been taught in successfully if the green LED flashes for 1.5 s at a frequency of 5 Hz.
- ⇒ The hysteresis function has been taught in successfully if the yellow LED flashes for 1.5 s at a frequency of 5 Hz.

Inverting the output function (NO/NC)

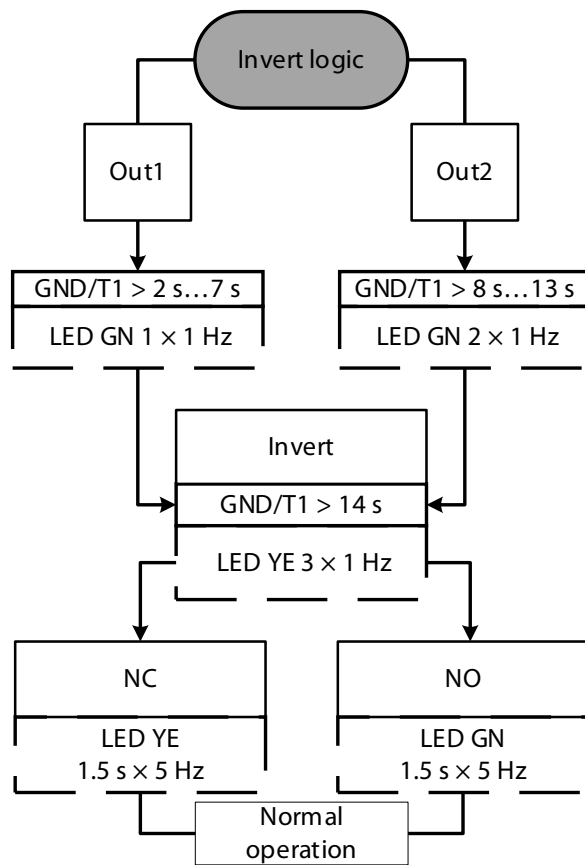

Fig. 41: Inverting the output function (NO/NC)

- ▶ Select the switching output.
- ▶ Press and hold down pushbutton 1 for 14...19 s.
- ⇒ The output function has been successfully inverted as an NO contact if the green LED flashes for 1.5 s at a frequency of 5 Hz.
- ⇒ The output function has been successfully inverted as an NC contact if the yellow LED flashes for 1.5 s at a frequency of 5 Hz.

Setting operation as a retroreflective sensor

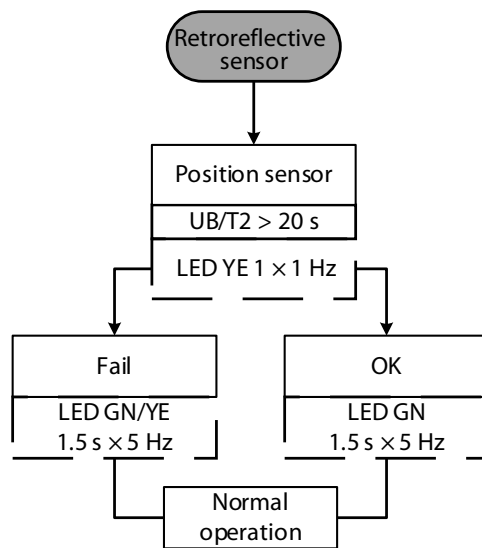

Fig. 42: Setting operation as a retroreflective sensor

- ▶ Position the reflector in the detection range.
- ▶ Press and hold down pushbutton 2 for at least 21 s.
- ⇒ The sensor is set successfully as a retroreflective sensor if the green LED flashes for 1.5 s at a frequency of 5 Hz.

Reset to factory settings

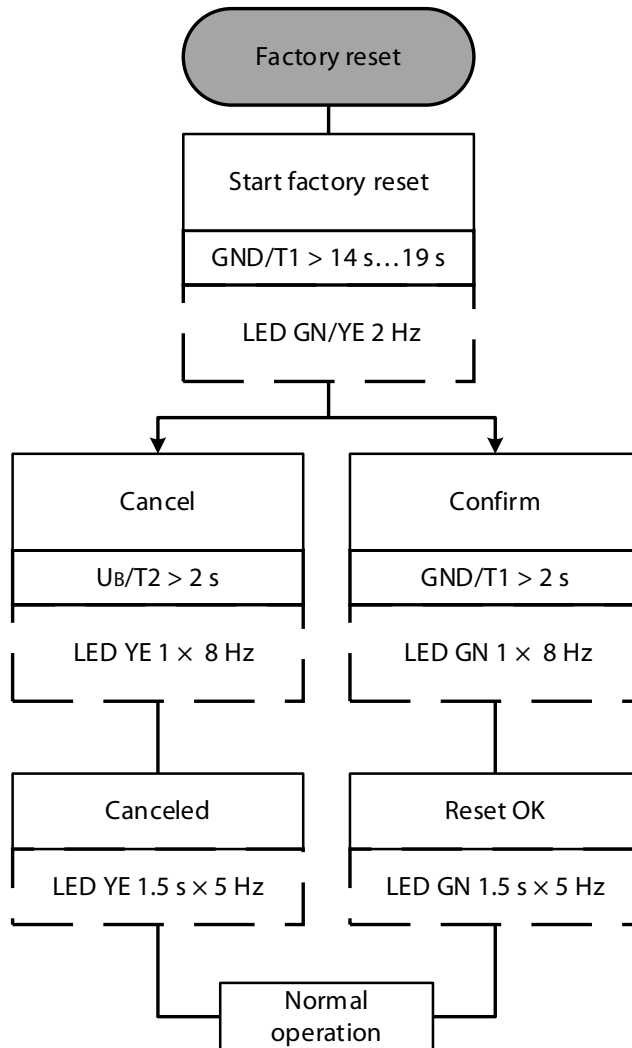

Fig. 43: Reset to factory settings

- ▶ Starting the reset to factory settings: Press and hold down pushbutton 1 for 14...19 s.
- ▶ Confirming the reset to factory settings: Press and hold down pushbutton 1 for 2...7 s.
- ⇒ The device has been successfully reset to the factory settings if the green LED flashes for 1.5 s at a frequency of 5 Hz.

Setting output 2 as a current output



NOTE

If output 2 is set as a current output, the closer teach-in point corresponds to limit value 1 (4 mA) and the teach-in point further away to limit value 2 (20 mA).

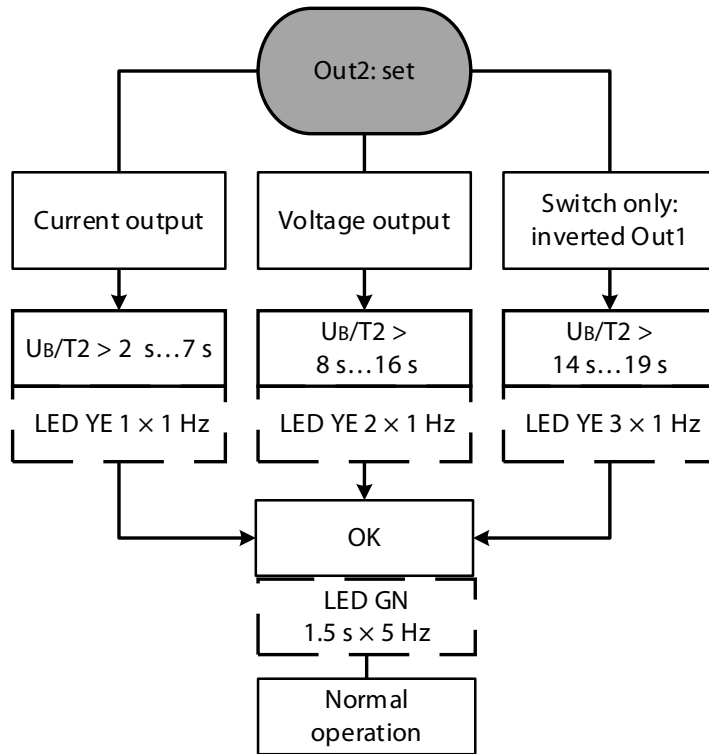

Fig. 44: Setting output 2

- ▶ Press and hold down pushbutton 2 for 2...7 s.
- ▶ Set limit values for the window function.
- ⇒ Output 2 is set successfully as a current output if the green LED flashes for 1.5 s at a frequency of 5 Hz.

Setting output 2 as a voltage output



NOTE

If output 2 is set as a voltage output, the closer teach-in point corresponds to limit value 1 (0 V) and the teach-in point further away to limit value 2 (10 V).

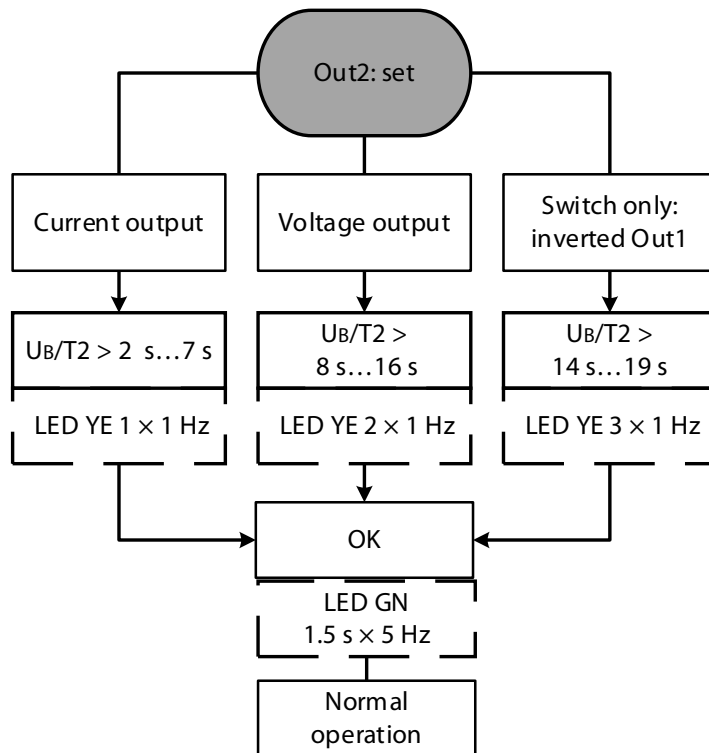

Fig. 45: Setting output 2

- ▶ Press and hold down pushbutton 2 for 8...13 s.
- ▶ Set limit values for the window function.
- ⇒ Output 2 is set successfully as a voltage output if the green LED flashes for 1.5 s at a frequency of 5 Hz.

Setting output 2 as a switching output

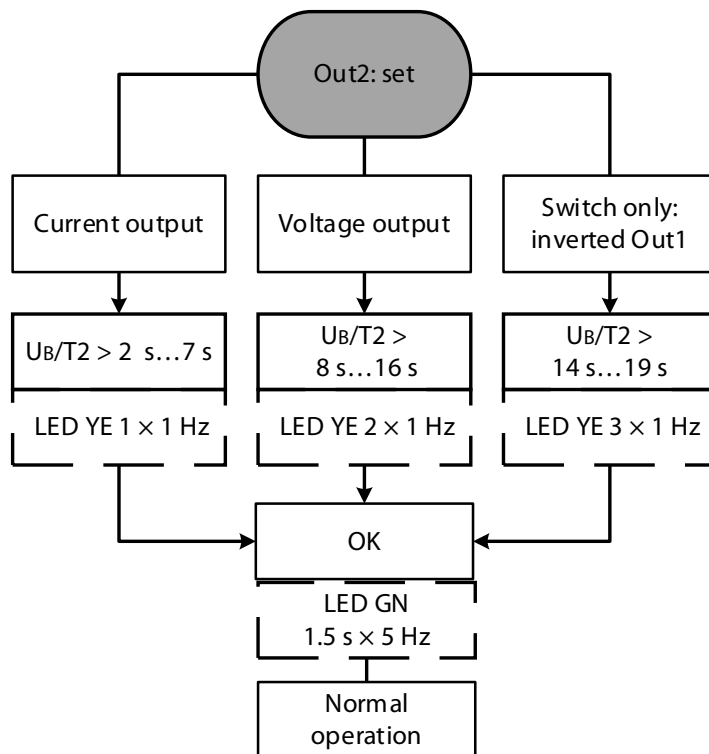

Fig. 46: Setting output 2

- ▶ Press and hold down pushbutton 2 for 14...19 s.
- ⇒ Output 2 is set successfully as a switching output if the green LED flashes for 1.5 s at a frequency of 5 Hz.

9.4 Setting via IO-Link

The following components are required for setting the device via IO-Link:

Hardware	Software	Documentation
<ul style="list-style-type: none"> ■ USB IO-Link adapter USB-2-IOL-0002 	<ul style="list-style-type: none"> ■ PACTware parameter software ■ DTM IODD Interpreter ■ IODD configuration file for RU Series ultrasonic sensors 	<ul style="list-style-type: none"> ■ IO-Link Devices Commissioning (D900633) ■ IO-Link parameters manual

Further information on operating modes and parameters in IO-Link mode is provided in the IO-Link Parameters manual.

10 Troubleshooting

If the device does not function as expected, first check whether ambient interference is present. If there is no ambient interference present, check the connections of the device for faults.

If there are no faults, there is a device malfunction. In this case, decommission the device and replace it with a new device of the same type.

11 Maintenance

To improve operation, wipe off dust and dirt from the face of the sonic transducer with a damp cloth if necessary.

The proper condition of connections and cables must be checked regularly.

The devices are maintenance-free.

12 Repair

The device must not be repaired by the user. The device must be decommissioned if it is faulty. Observe our return acceptance conditions when returning the device to Turck.

12.1 Returning devices

Returns to Turck can only be accepted if the device has been equipped with a Decontamination declaration enclosed. The decontamination declaration can be downloaded from

<https://www.turck.de/en/retoure-service-6079.php>

and must be completely filled in, and affixed securely and weather-proof to the outside of the packaging.

13 Disposal



The devices must be disposed of correctly and must not be included in general household garbage.

14 Technical Data



Technical data	RU40U...-M18...	RU130U...-M18...	RU130U...-M30...
Blind zone S_{\min}	2.5 cm	15 cm	15 cm
Operating range	40 cm	130 cm	130 cm
Resolution	0.5 mm	1 mm	1 mm
Minimum size			
– switching range	5 mm	10 mm	10 mm
– measuring range	50 mm	100 mm	100 mm
Operating voltage	15...30 VDC	15...30 VDC	15...30 VDC
Rated operational current	≤ 150 mA	≤ 150 mA	≤ 150 mA
No-load current	≤ 50 mA	≤ 50 mA	≤ 50 mA
Operating temperature	-25...+45 °C	-25...+45 °C	-25...+45 °C
Storage temperature	-40...+80 °C	-40...+80 °C	-40...+80 °C
Switching hysteresis	5 mm	10 mm	10 mm
Switching frequency	7Hz	8 Hz	8 Hz
Approvals	CE, cULus	CE, cULus	CE, cULus

Technical data	RU300U...-M30...	RU600U...-M30...
Blind zone S_{\min}	30 cm	60 cm
Operating range	300 cm	600 cm
Resolution	1 mm	1 mm
Minimum size	25 mm	50 mm
– switching range	250 mm	500 mm
– measuring range		
Operating voltage	15...30 VDC	15...30 VDC
Rated operational current	≤ 150 mA	≤ 150 mA
No-load current	≤ 50 mA	≤ 50 mA
Operating temperature	-25...+45 °C	-25...+45 °C
Storage temperature	-40...+80 °C	-40...+80 °C
Switching hysteresis	25 mm	50 mm
Switching frequency	4 Hz	1.6 Hz
Approvals	CE, cULus	CE, cULus

UL conditions: T_a 0...+85 °C, use the same power supply for all circuits.

15 Appendix

15.1 Approvals and markings

Approvals	Marking in accordance with the ATEX Directive	EN 60079-0/-7/-15/-31
ATEX approval no.: BVS 16 ATEX E021 X	 	Ex ec nC IIC T6 Gc Ex ec IIC T6 Gc Ex tc IIIC T70°C Dc
		
IECEX approval no.: IECEX BVS 16.0035X		Ex ec nC IIC T6 Gc Ex ec IIC T6 Gc Ex tc IIIC T70°C Dc

Ambient temperature T_{amb} : -25...+45 °C

15.2 Approvals: cULus

Further requirements for mounting in UL installations:

- Use the same voltage for all circuits.
- Install the ultrasonic sensors with UL-listed connection cables (approved for 30 V and 0.15 A min.) in the electrical installation of the plant.

15.3 Conformity Certificates

EU-Konformitätserklärung Nr.: 5129-1M
 EU Declaration of Conformity No.:



Wir/ We: **HANS TURCK GMBH & CO KG**
WITZLEBENSTR. 7, 45472 MÜLHEIM A.D. RUHR

erklären in alleiniger Verantwortung, dass die Produkte
 declare under our sole responsibility that the products

Ultraschall-Sensoren: **RU***U-****(**)-**(***)8X2(*)-H1151/S****/3GD**
 ultrasonic sensors:

auf die sich die Erklärung bezieht, den Anforderungen der folgenden EU-Richtlinien durch Einhaltung der
 folgenden Normen genügen:
 to which this declaration relates are in conformity with the requirements of the following EU-directives by compliance with the following
 standards:

EMV - Richtlinie /EMC Directive EN 60947-5-2:2007/A1:2012	2014 / 30 / EU	26.02.2014
ATEX - Richtlinie /Directive ATEX EN IEC 60079-0:2018 EN IEC 60079-7:2015+A1:2018 EN IEC 60079-15:2019 EN 60079-31:2014	2014 / 34 / EU	26.02.2014
RoHS – Richtlinie /RoHS Directive EN IEC 63000:2018	2011 / 65 / EU	08.06.2011

Weitere Normen, Bemerkungen:
 additional standards, remarks:

Zusätzliche Informationen:
 Supplementary information:

Angewandtes ATEX-Konformitätsbewertungsverfahren: **Modul A /module A**
 ATEX - conformity assessment procedure applied:

Baumusterprüfbescheinigung: **BVS 16 ATEX E 021 X**
 examination certificate:

ausgestellt: **DEKRA EXAM GmbH,**
 issued by: **Dinnendahlstraße 9, 44809 Bochum**
Kenn-Nr. /number: 0158

Mülheim a. d. Ruhr, den 19.01.2021

Ort und Datum der Ausstellung /
 Place and date of issue

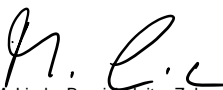
 i.V. Dr. M. Linde, Bereichsleiter Zulassungen /Head of Approvals
 Name, Funktion und Unterschrift des Befugten /
 Name, function and signature of authorized person

15.4 Approvals

15.4.1 EC-type examination certificate



Translation

1 Type Examination Certificate

2 **Equipment or Protective System intended for use in potentially explosive atmospheres
Directive 2014/34/EU**

3 Type Examination Certificate Number: **BVS 16 ATEX E 021 X**

4 Product: **Ultrasonic sensor type RU***-M***-***8X2*-H1151/S****3GD**

5 Manufacturer: **Werner Turck GmbH & Co. KG**

6 Address: **Goethestr. 7, 58545 Halver, Germany**

7 This product and any acceptable variation thereto are specified in the appendix to this certificate and the documents therein referred to.

8 DEKRA EXAM GmbH certifies that this product has been found to comply with the Essential Health and Safety Requirements relating to the design and construction of products intended for use in potentially explosive atmospheres given in Annex II to the Directive.
The examination and test results are recorded in the Confidential Report No. BVS PP 16.2092 EU.

9 Compliance with the Essential Health and Safety Requirements has been assured by compliance with:

EN 60079-0:2012 + A11:2013 General requirements
EN 60079-15:2010 Type of Protection "n"
EN 60079-31:2014 Protection by Enclosure "t"

10 If the sign "X" is placed after the certificate number, it indicates that the product is subject to the Specific Conditions of Use specified in the appendix to this certificate.

11 This Type Examination Certificate relates only to the design and construction of the specified product. Further requirements of the Directive apply to the manufacturing process and supply of this product. These are not covered by this certificate.

12 The marking of the product shall include the following:

II 3G Ex nA nC IIC T6 Gc with teach button
II 3D Ex tc IIIC T70°C Dc
 Or
II 3G Ex nA IIC T6 Gc without teach button
II 3D Ex tc IIIC T70°C Dc

DEKRA EXAM GmbH
Bochum, 2016-05-19

Signed: Simanski

Certifier

Signed: Dr Eickhoff

Approver

Page 1 of 3 of BVS 16 ATEX E 021 X
This certificate may only be reproduced in its entirety and without any change.
DEKRA EXAM GmbH, Dinnendahlstrasse 9, 44809 Bochum, Germany,
telephone +49.234.3696-105, Fax +49.234.3696-110, zs-exam@dekra.com





13 **Appendix**

14 **Type Examination Certificate**

BVS 16 ATEX E 021 X

15 **Product description**

15.1 **Subject and type**

Ultrasonic sensor type RU***-M***-***8X2*-H1151/S****/3GD

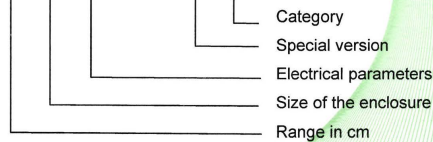

15.2 **Description**

The ultrasonic sensor is used for contactless capture of objects. The ultrasonic diffuse mode sensor detects all objects that echo back ultrasonic waves. The sensor consists of a stainless steel enclosure with an external thread in size M18 or M30. For adjusting the measuring range the sensor is optionally equipped with teach buttons.

The ultrasonic sensor is designed in type of protection 'n' for use in category 3G and in type of protection by enclosure 't' for category 3D.

15.3 **Parameters**

15.3.1 **Electrical data**

Nominal voltage	15...30	VDC
Nominal current	≤ 150	mA
Ultrasonic frequency	80 up to 300	kHz

15.3.2 **Thermal data**

Ambient temperature range -25 °C ≤ T_A ≤ 45 °C

16 **Report Number**

BVS PP 16.2092 EU, as of 2016-05-19

17 **Special Conditions of Use**

17.1 The connection of the sensor with integrated M12 flange socket must be equipped with an M12 connector separately certified for this purpose. The connector has to comply with the requirements according EN/IEC 61076-2-101.

17.2 The external earthing has to be established by the end user in the end use application.

18 **Essential Health and Safety Requirements**

The Essential Health and Safety Requirements covered by the standards listed under item 9.

19 **Drawings and Documents**

Drawings and documents are listed in the confidential report.

Page 2 of 3 of BVS 16 ATEX E 021 X
This certificate may only be reproduced in its entirety and without any change.



DEKRA EXAM GmbH, Dinnendahlstrasse 9, 44809 Bochum, Germany,
telephone +49.234.3696-105, Fax +49.234.3696-110. zs-exam@dekra.com



We confirm the correctness of the translation from the German original.
In the case of arbitration only the German wording shall be valid and binding.

DEKRA EXAM GmbH
Bochum, dated 2016-05-19
BVS-Pe/Nu A 20151005

Certifier

Approver

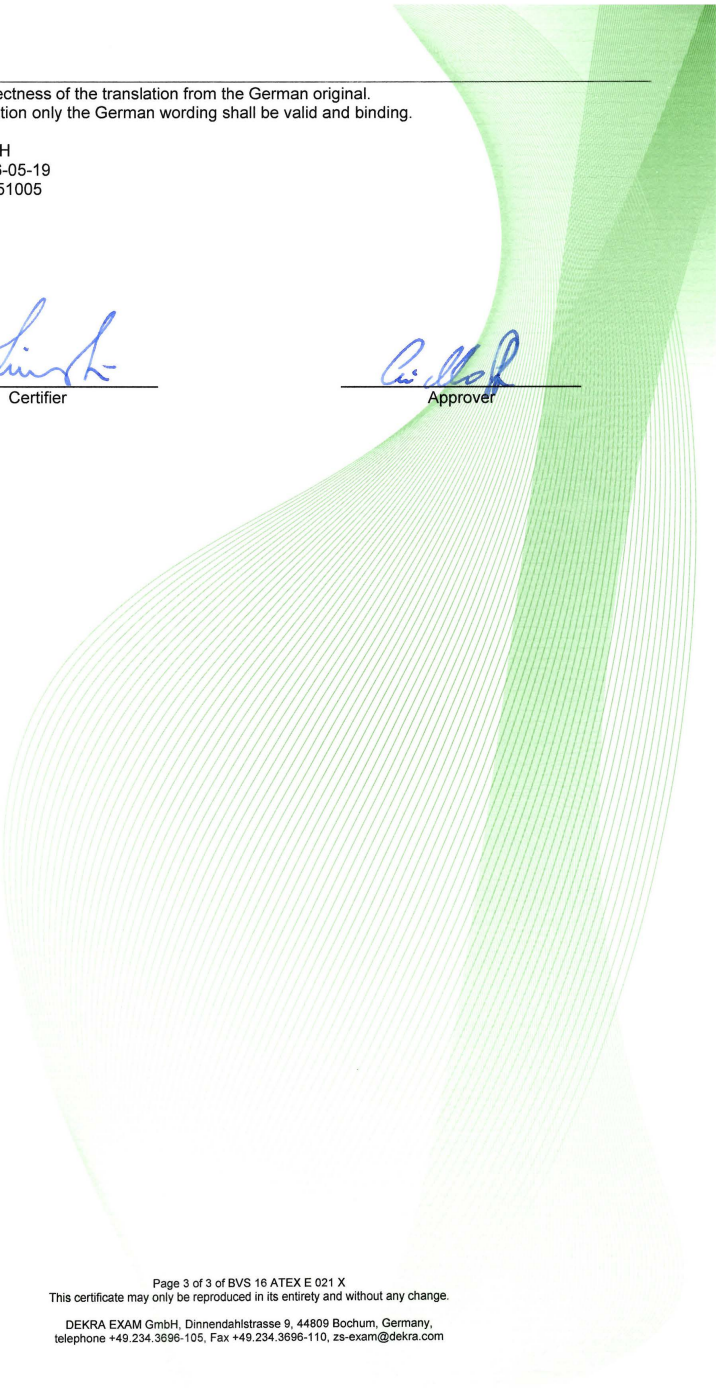

Page 3 of 3 of BVS 16 ATEX E 021 X
This certificate may only be reproduced in its entirety and without any change.

DEKRA EXAM GmbH, Dinnendahlstrasse 9, 44809 Bochum, Germany,
telephone +49.234.3696-105, Fax +49.234.3696-110, zs-exam@dekra.com

15.4.2 IECEx

		<h2>IECEX Certificate of Conformity</h2>	
<p>INTERNATIONAL ELECTROTECHNICAL COMMISSION IEC Certification Scheme for Explosive Atmospheres <small>for rules and details of the IECEx Scheme visit www.iecex.com</small></p>			
Certificate No.:	IECEX BVS 16.0035X	Issue No: 0	Certificate history Issue No. 0 (2016-05-31)
Status:	Current	Page 1 of 4	
Date of Issue:	2016-05-31		
Applicant:	Werner Turck GmbH & Co. KG Goethestr. 7 58545 Halver Germany		
Electrical Apparatus: <i>Optional accessory:</i>	Ultrasonic sensor type RU***-N***-***X2-HI 1S1/S***/3GD		
Type of Protection:	Equipment protection by type of protection "n", Equipment dust ignition protection by enclosure "T"		
Marking:	Ex nA nC IIC T6 Gc	with teach button	
	Ex tc IIIC T70°C Dc		
	Ex nA IIC T6 Gc	without teach button	
	Ex tc IIIC T70°C Dc		
Approved for issue on behalf of the IECEx Certification Body:	H.-Ch. Simanski		
Position:	Head of Certification Body		
Signature: <i>(for printed version)</i>	_____		
Date:	_____		
1. This certificate and schedule may only be reproduced in full. 2. This certificate is not transferable and remains the property of the issuing body. 3. The Status and authenticity of this certificate may be verified by visiting the Official IECEx Website.			
Certificate issued by:	 <p>DEKRA On the safe side.</p>		
	<p>DEKRAEXAM GmbH Dinnendahlstrasse 9 44809 Bochum Germany</p>		



IECEX Certificate of Conformity

Certificate No: IECEX BVS 16.0035X Issue No: 0
Date of Issue: 2016-05-31 Page 2 of 4
Manufacturer: **Werner Turck GmbH & Co. KG**
Goethestr. 7
58545 Halver
Germany

Additional Manufacturing
location(s):

This certificate is issued as verification that a sample(s), representative of production, was assessed and tested and found to comply with the IEC Standard list below and that the manufacturer's quality system, relating to the Ex products covered by this certificate, was assessed and found to comply with the IECEX Quality system requirements. This certificate is granted subject to the conditions as set out in IECEX Scheme Rules, IECEX 02 and Operational Documents as amended.

STANDARDS:

The electrical apparatus and any acceptable variations to it specified in the schedule of this certificate and the identified documents, was found to comply with the following standards:

IEC 60079-0 : 2011 Edition:6.0	Explosive atmospheres - Part 0: General requirements
IEC 60079-15 : 2010 Edition:4	Explosive atmospheres - Part 15: Equipment protection by type of protection "n"
IEC 60079-31 : 2013 Edition:2	Explosive atmospheres - Part 31: Equipment dust ignition protection by enclosure "t"

*This Certificate **does not** indicate compliance with electrical safety and performance requirements other than those expressly included in the Standards listed above.*

TEST & ASSESSMENT REPORTS:

A sample(s) of the equipment listed has successfully met the examination and test requirements as recorded in

Test Report:

[DE/BVS/ExTR16.0040/00](#)

Quality Assessment Report:

[DE/PTB/QAR06.0012/03](#)



IECEX Certificate of Conformity

Certificate No: IECEX BVS 16.0035X

Issue No: 0

Date of Issue: **2016-05-31**

Page 3 of 4

Schedule

EQUIPMENT:

Equipment and systems covered by this certificate are as follows:

Subject and Type

See Annex

Description

The ultrasonic sensor is used for contactless capture of objects. The ultrasonic diffuse mode sensor detects all objects that echo back ultrasonic waves. The sensor consists of a stainless steel enclosure with an external thread in size M18 or M30. For adjusting the measuring range the sensor is optionally equipped with teach buttons. The ultrasonic sensor is designed in type of protection 'n' for use in category 3G and in type of protection by enclosure 't' for category 3D.

CONDITIONS OF CERTIFICATION: YES as shown below:

The connection of the sensor with integrated M12 flange socket must be equipped with an M12 connector separately certified for this purpose. The connector has to comply with the requirements according EN/IEC 61076-2-101.

The external earthing has to be established by the end user in the end use application.



IECEX Certificate of Conformity

Certificate No: IECEX BVS 16.0035X

Issue No: 0

Date of Issue: 2016-05-31

Page 4 of 4

EQUIPMENT (continued):

Parameters

Electrical data

Nominal voltage 15...30 VDC

Nominal current ≤ 150 mA

Ultrasonic frequency 80 up to 300 kHz

Thermal data

Ambient temperature range -25 °C $\leq T_A \leq 45$ °C

Annex:

[BVS_16_0035X_WemerTurck_Annex.pdf](#)



IECEX Certificate of Conformity



Certificate No.: IECEx BVS 16.0035X
Annex
Page 1 of 1

Subject and Type

Ultrasonic sensor type RU***-M***-***8X2*-H1151/S****/3GD

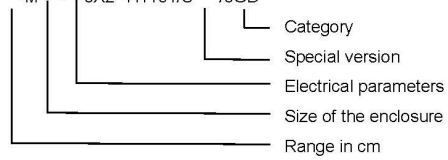

16 Turck Subsidiaries - Contact Information

Germany	Hans Turck GmbH & Co. KG Witzlebenstraße 7, 45472 Mülheim an der Ruhr www.turck.de
Australia	Turck Australia Pty Ltd Building 4, 19-25 Duerdin Street, Notting Hill, 3168 Victoria www.turck.com.au
Belgium	TURCK MULTIPROX Lion d'Orweg 12, B-9300 Aalst www.multiprox.be
Brazil	Turck do Brasil Automação Ltda. Rua Anjo Custódio Nr. 42, Jardim Anália Franco, CEP 03358-040 São Paulo www.turck.com.br
China	Turck (Tianjin) Sensor Co. Ltd. 18,4th Xinghuazhi Road, Xiqing Economic Development Area, 300381 Tianjin www.turck.com.cn
France	TURCK BANNER S.A.S. 11 rue de Courtalin Bat C, Magny Le Hongre, F-77703 MARNE LA VALLEE Cedex 4 www.turckbanner.fr
Great Britain	TURCK BANNER LIMITED Blenheim House, Hurricane Way, GB-SS11 8YT Wickford, Essex www.turckbanner.co.uk
India	TURCK India Automation Pvt. Ltd. 401-403 Aurum Avenue, Survey. No 109 /4, Near Cummins Complex, Baner-Balewadi Link Rd., 411045 Pune - Maharashtra www.turck.co.in
Italy	TURCK BANNER S.R.L. Via San Domenico 5, IT-20008 Bareggio (MI) www.turckbanner.it
Japan	TURCK Japan Corporation Syuuhou Bldg. 6F, 2-13-12, Kanda-Sudacho, Chiyoda-ku, 101-0041 Tokyo www.turck.jp
Canada	Turck Canada Inc. 140 Duffield Drive, CDN-Markham, Ontario L6G 1B5 www.turck.ca
Korea	Turck Korea Co, Ltd. B-509 Gwangmyeong Technopark, 60 Haan-ro, Gwangmyeong-si, 14322 Gyeonggi-Do www.turck.kr
Malaysia	Turck Banner Malaysia Sdn Bhd Unit A-23A-08, Tower A, Pinnacle Petaling Jaya, Jalan Utara C, 46200 Petaling Jaya Selangor www.turckbanner.my

Mexico	Turck Comercial, S. de RL de CV Blvd. Campestre No. 100, Parque Industrial SERVER, C.P. 25350 Arteaga, Coahuila www.turck.com.mx
Netherlands	Turck B. V. Ruiterlaan 7, NL-8019 BN Zwolle www.turck.nl
Austria	Turck GmbH Graumanngasse 7/A5-1, A-1150 Wien www.turck.at
Poland	TURCK sp.z.o.o. Wroclawska 115, PL-45-836 Opole www.turck.pl
Romania	Turck Automation Romania SRL Str. Siriului nr. 6-8, Sector 1, RO-014354 Bucuresti www.turck.ro
Russian Federation	TURCK RUS OOO 2-nd Pryadilnaya Street, 1, 105037 Moscow www.turck.ru
Sweden	Turck Sweden Office Fabriksstråket 9, 433 76 Jonsered www.turck.se
Singapore	TURCK BANNER Singapore Pte. Ltd. 25 International Business Park, #04-75/77 (West Wing) German Centre, 609916 Singapore www.turckbanner.sg
South Africa	Turck Banner (Pty) Ltd Boeing Road East, Bedfordview, ZA-2007 Johannesburg www.turckbanner.co.za
Czech Republic	TURCK s.r.o. Na Brne 2065, CZ-500 06 Hradec Králové www.turck.cz
Turkey	Turck Otomasyon Ticaret Limited Sirketi Inönü mah. Kayisdagi c., Yesil Konak Evleri No: 178, A Blok D:4, 34755 Kadiköy/ Istanbul www.turck.com.tr
Hungary	TURCK Hungary kft. Árpád fejedelem útja 26-28., Óbuda Gate, 2. em., H-1023 Budapest www.turck.hu
USA	Turck Inc. 3000 Campus Drive, USA-MN 55441 Minneapolis www.turck.us

TURCK

Over 30 subsidiaries and over
60 representations worldwide!

D102265 | 2021/09



www.turck.com