

PKG4M-2/TEL

Actuator, Sensor and Supply Cable, PVC – Connection Cable

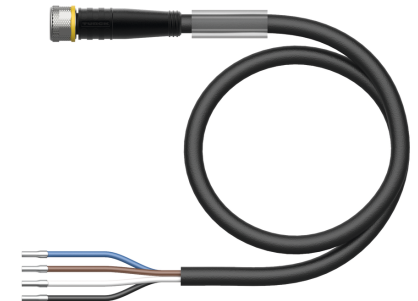
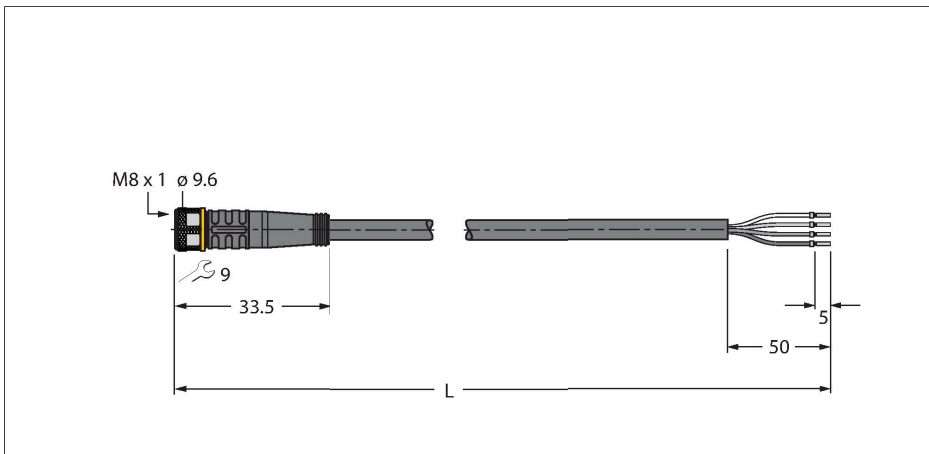

Technical data

Type	PKG4M-2/TEL
ID	6625061
Connector A	Female, M8 × 1, Straight
Number of Pins	4
Contacts	Brass, CuZn, Gold-plated
Contact carriers	Plastic, TPU, Black
Connector body	Plastic, TPU, Black
Coupling nut/screw	Brass, CuZn, Nickel-plated
Seal	Plastic, FPM/FKM
Tightening torque (range)	0.5 ... 0.6 Nm (observe max. torque of mating connector!)
Mechanical lifespan	> 100 Mating cycles
Pollution degree	3
Protection class	IP67, IP69K, Only in screwed condition
Cable	
Cable diameter	Ø 4.6 mm ±0.20
Cable length	2 m
Cable jacket	PVC, Black
Core insulation	PVC
Core cross-section	4 x 0.34 mm ²
Arrangement of strands	42 x 0.1 mm
Core colors	BN, WH, BU, BK
Electrical properties at +20 °C	
Rated voltage	50 V _{AC} /60 V _{DC}
Test voltage	2000 V
Current	4 A
Insulation resistance	> 30.5 MΩ/km

Features



- Female M8, straight, 4-pin
- Jacket material: PVC
- Jacket color: black
- Resistant to chemicals and oils
- Flame retardant
- Resistant to acids and alkaline solutions
- Resistant to microbes and hydrolysis
- LABS free
- Protection class: IP67, IP69K
- Cable length: 2.0 m

Cable Cross-Section

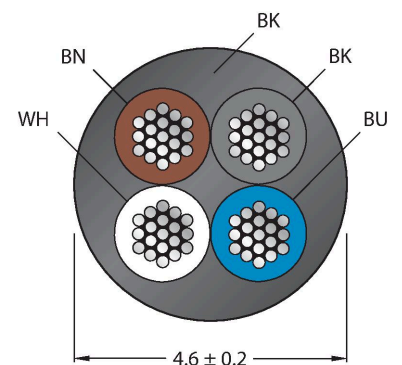

Contact assignment



Technical data

forward resistance max. 57 Ω/km

Mechanical and chemical properties

Bending radius (stationary installation) ≥ 5 x Ø

Bending radius (flexible use) ≥ 10 x Ø

Ambient temperature range (stationary) -40...+105 °C

Ambient temperature range (In motion) -5...+80 °C

Approvals cULus

Circuit Diagram



Accessories

HAS5141-0

6905403

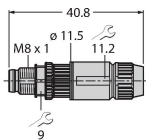

Field-wireable male connector, M8 × 1, straight, 4-pin, insulation piercing connection, cable feedthrough 2.5 to 5.1 mm, core cross-section/terminal capacity 0.14 to 0.34 mm², plastic housing, metal nut

BS5143-0

6901013

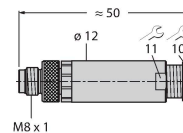

Field-wireable male connector, M8 × 1, straight, 4-pin, screw terminal connection, cable feedthrough 3.5 to 5.0 mm, core cross-section/terminal capacity 0.14 to 0.50 mm², plastic housing, metal retaining screw

HS5141-0

6902730

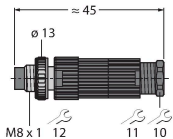

Field-wireable male connector, M8 × 1, straight, 4-pin, pressfit technology, cable feedthrough 4.0 to 5.0 mm, core cross-section/terminal capacity 0.14 to 0.34 mm², plastic housing, metal nut

HS5241-0

6902830

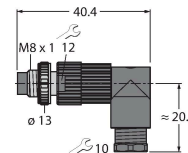

Field-wireable male connector, M8 × 1, angled, 4-pin, pressfit technology, cable feedthrough 4.0 to 5.0 mm, core cross-section/terminal capacity 0.14 to 0.34 mm², plastic housing, metal nut

FW-PRSPM0420-SA-S-0406

100002295

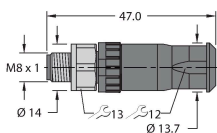

Field-wireable male connector, M8 × 1, straight, 4-pin, screw terminal connection, cable feedthrough 4.0 to 5.5 mm, core cross-section/terminal capacity 0.14 to 0.5 mm², plastic housing, metal retaining screw

TORQUE-WRENCH-SET-AS

6936170

Torque wrench set; handles with adjustable torque 0.4-1.0 Nm, torque wrench for M8 (SW9), fork wrench for M12 (SW 14)

BLANK-LABEL-FOR-CORDSETS-TEL-TXL

6936206

Label for TEL and TXL cables, length: 18 mm, height: 4 mm, material: polycarbonate (PC), color: white, halogen-free and flame-retardant

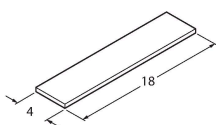

Accessories

Dimension drawing	Type	ID	
	LABEL-HOLDER-FLEX-PVC	100048170	PVC label holder for identification of extension cables (TEL/TXL product series); for cable diameters: min. 5 mm; dimensions 4 × 18 mm; delivery unit: 50 pcs. per package